

ab 12.01.2016
from 12.01.2016
à partir du 12.01.2016

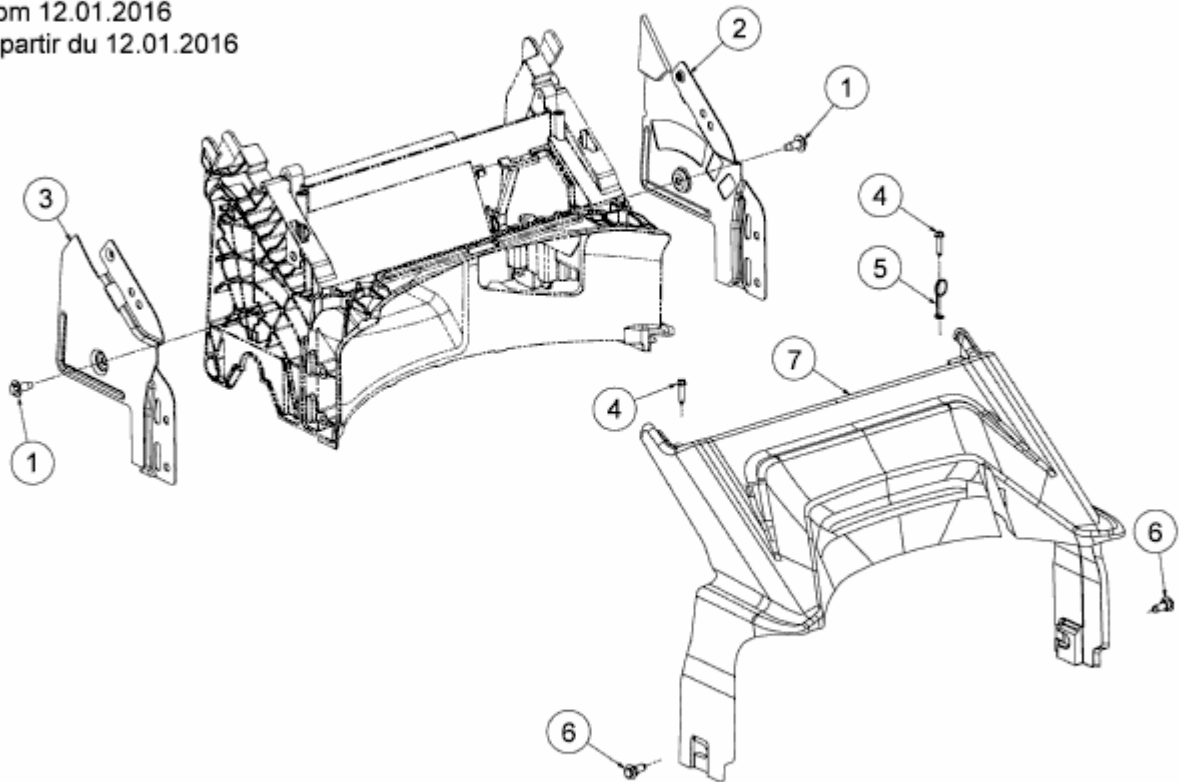

E3-09695A-01