

ab 19.12.2015
from 19.12.2015
à partir du 19.12.2015

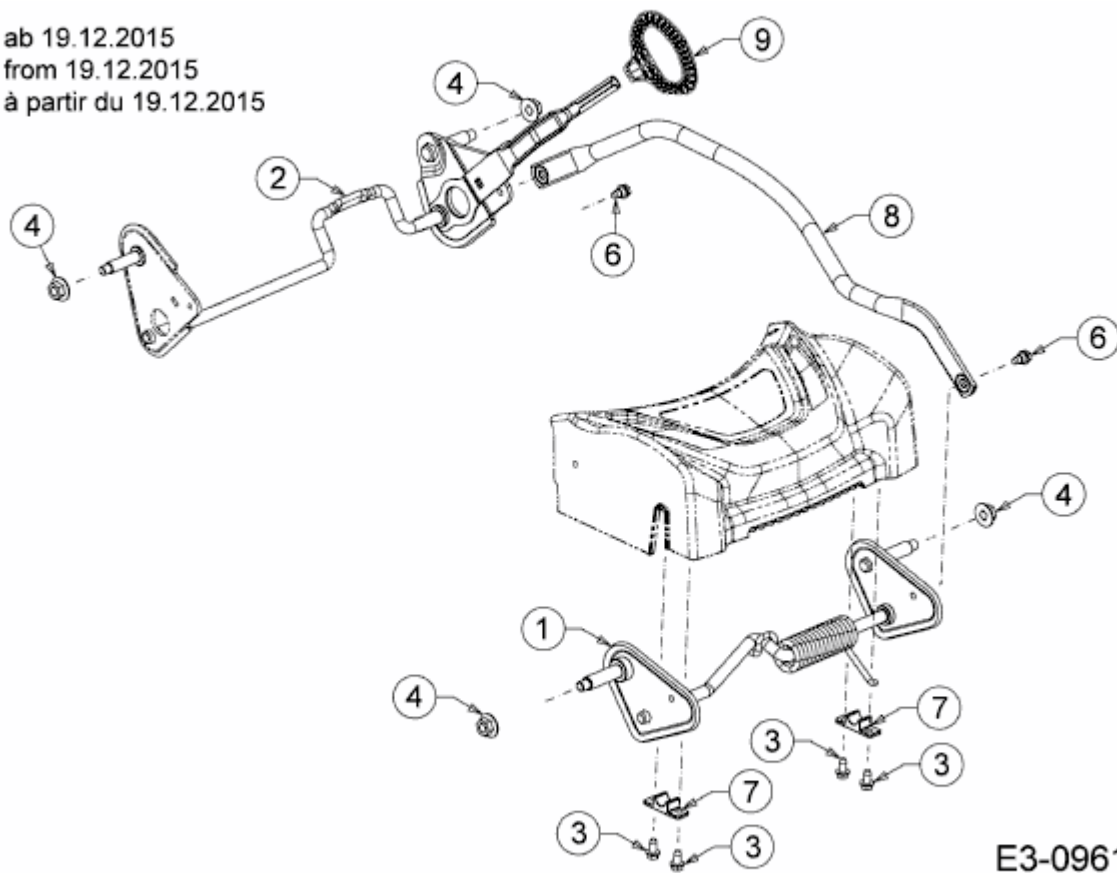

E3-09615A-02