

HW 46 BA-ES > 12AETNS7629 (2016) > GRASFANGSACK, HECKKLAPPE, LEITSTÜCK
HINTEN

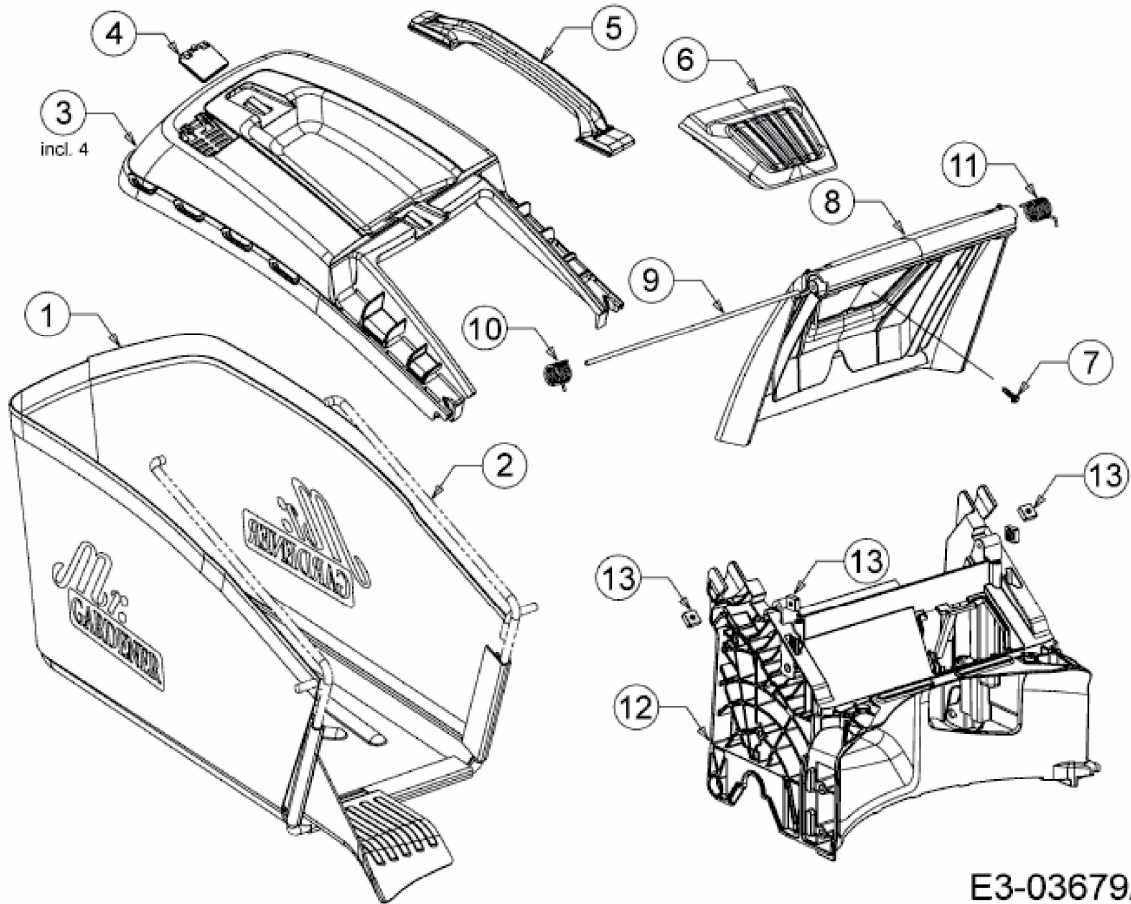

E3-03679A-01