

ab 14.12.2016
from 14.12.2016
à partir du 14.12.2016

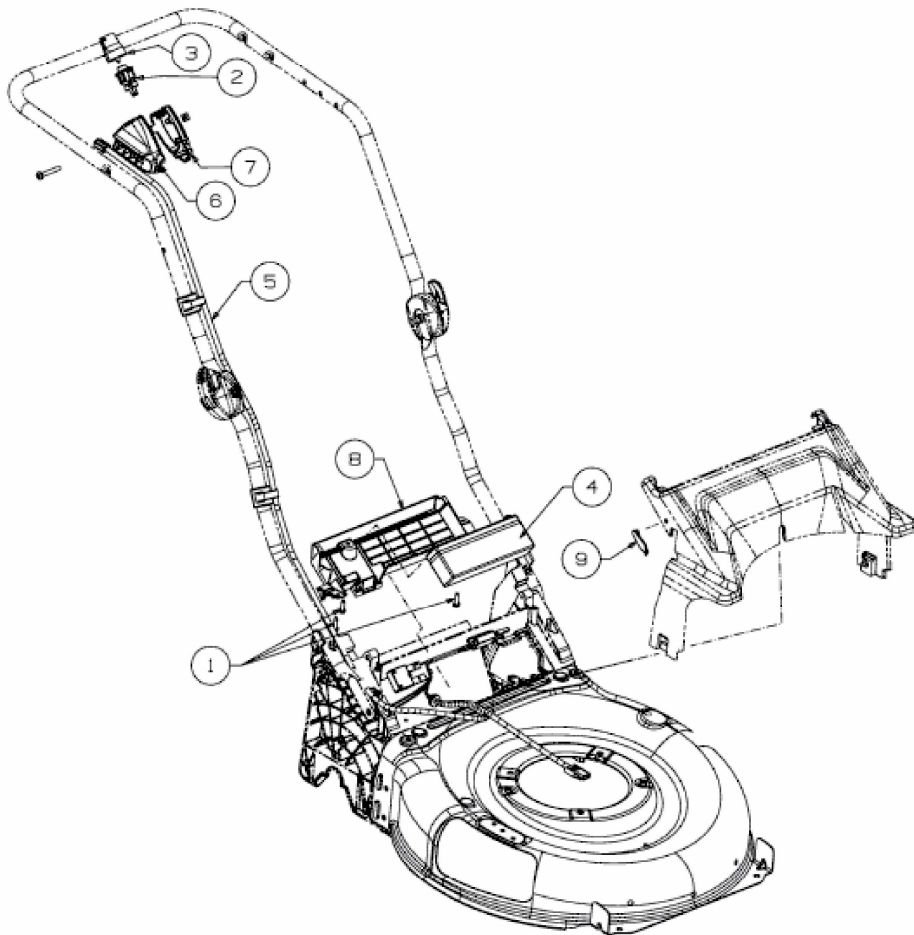

E3-02783C-92