

YM 6021 CKE > 12AE997F643 (2010) > GESCHWINDIGKEITSREGELUNG

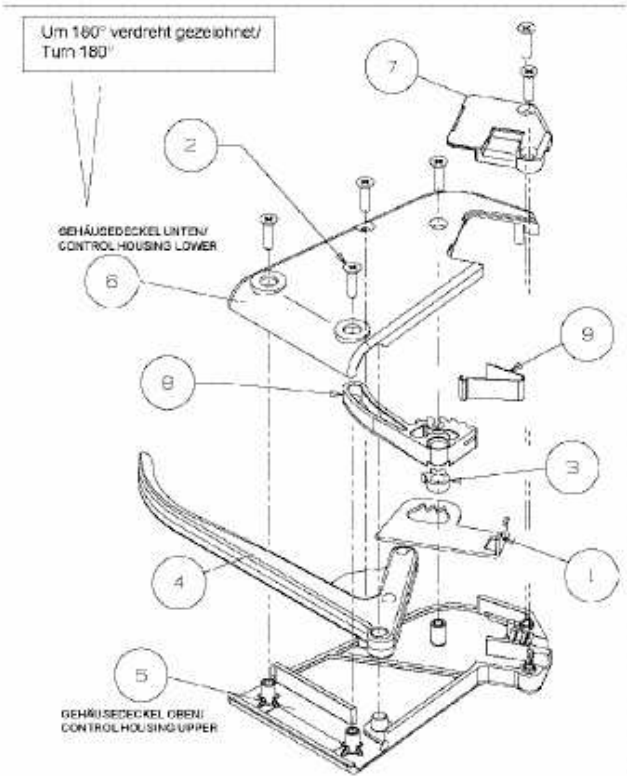
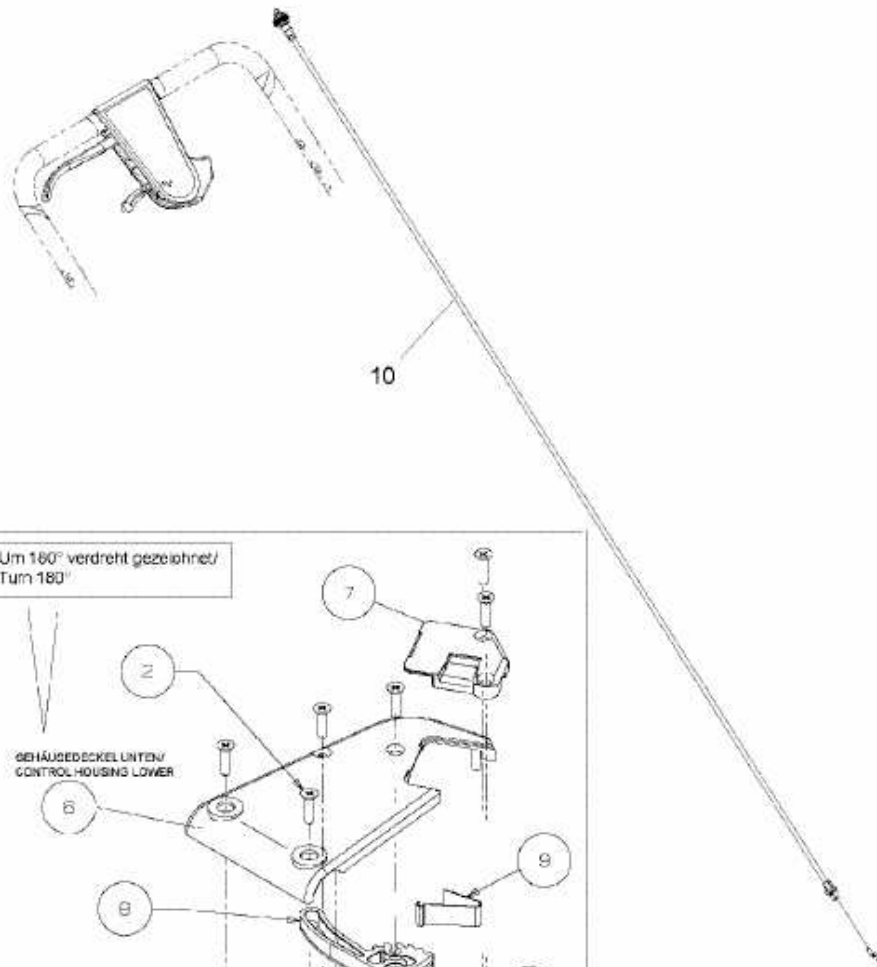

E3-02932A-01