

ab 06/02/2018
effective from 02/06/2018
à partir du 06/02/2018

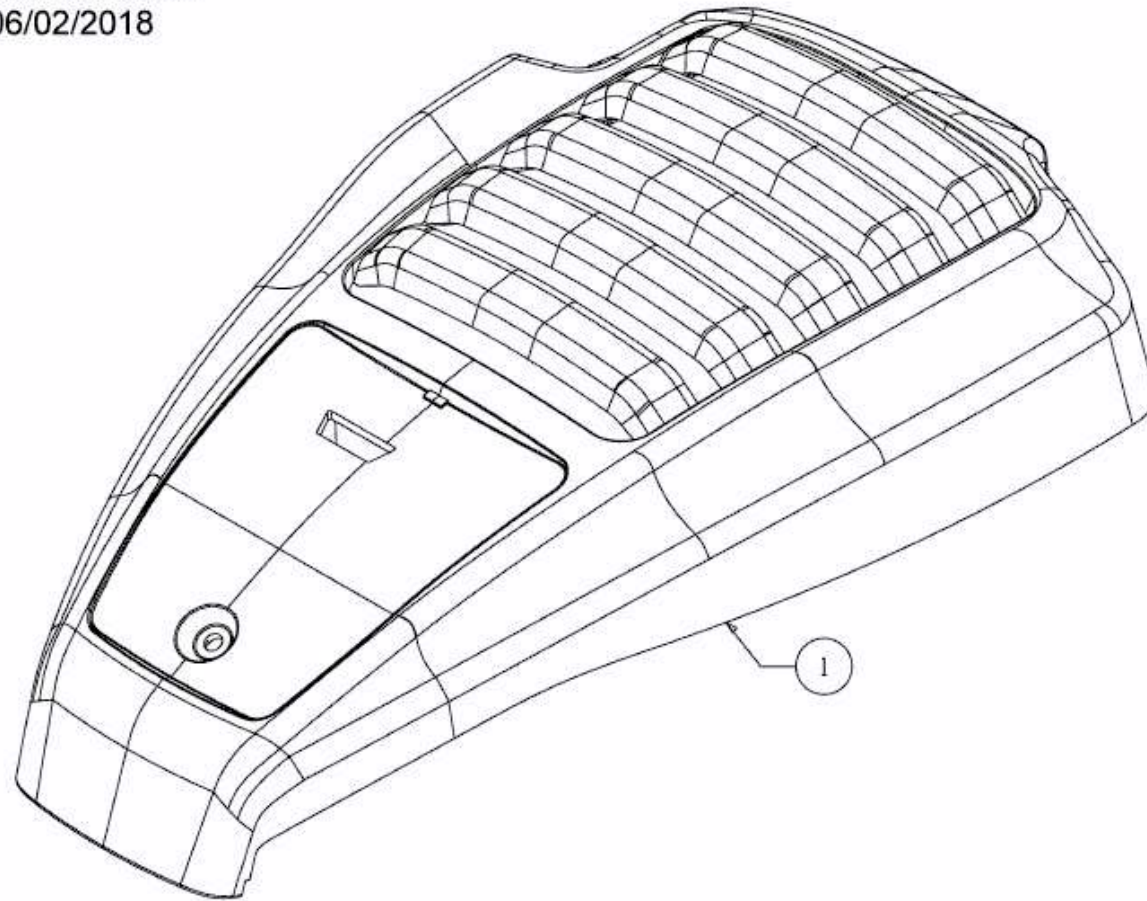

E3-00065A-01