

ab 15.11.2017
from 15.11.2017
à partir du 15.11.2017

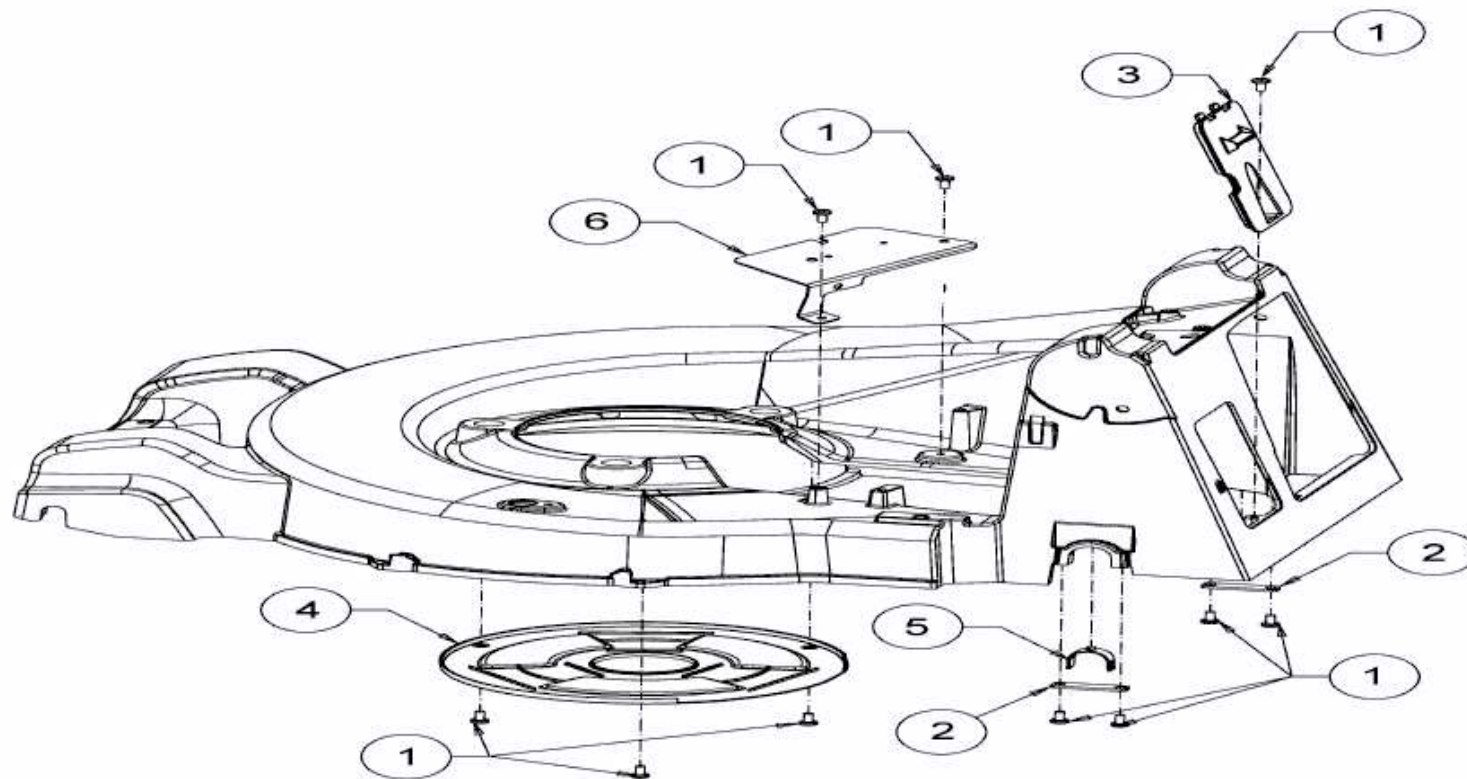

E3-00062A-01