

[LM 3 CRC 46 S](#) > [12ABTVSC603 \(2018\)](#) > [Grasfangsack, Heckklappe, Leitstück hinten](#)

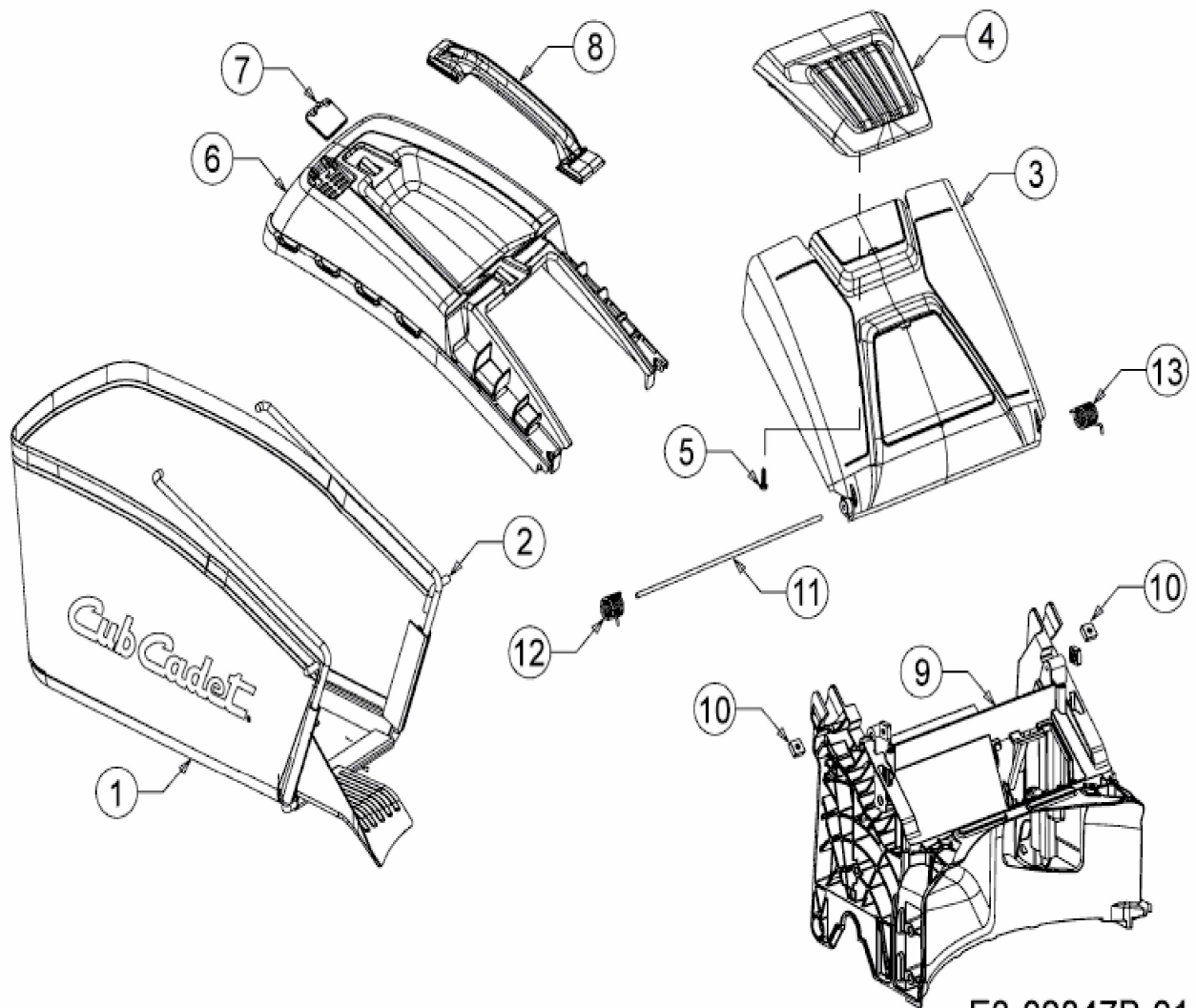

E3-02847B-01