

ab 22/11/2017
effective from 11/22/2017
à partir du 22/11/2017

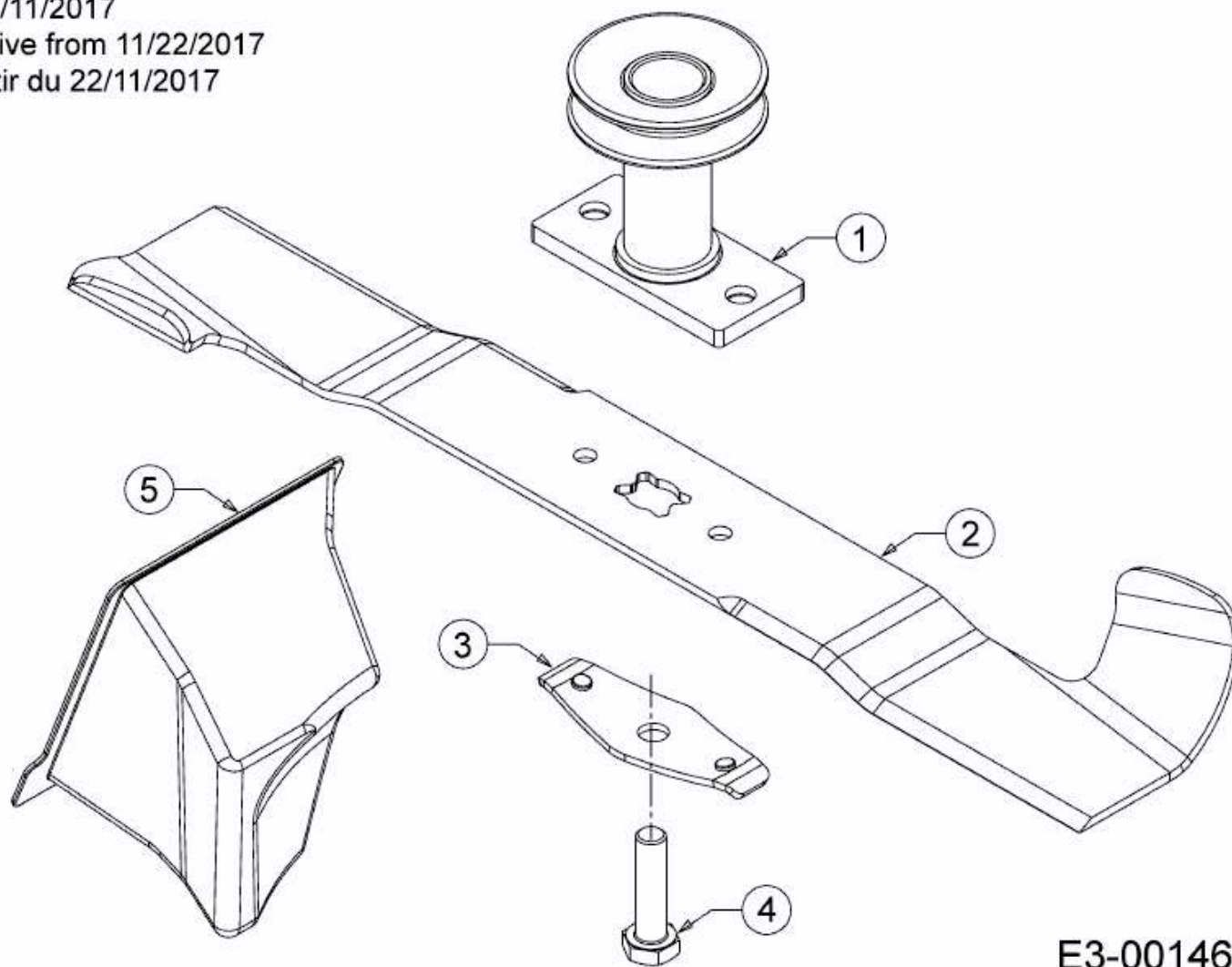

E3-00146A-01