

ab 10.12.2015  
from 10.12.2015  
à partir du 10.12.2015

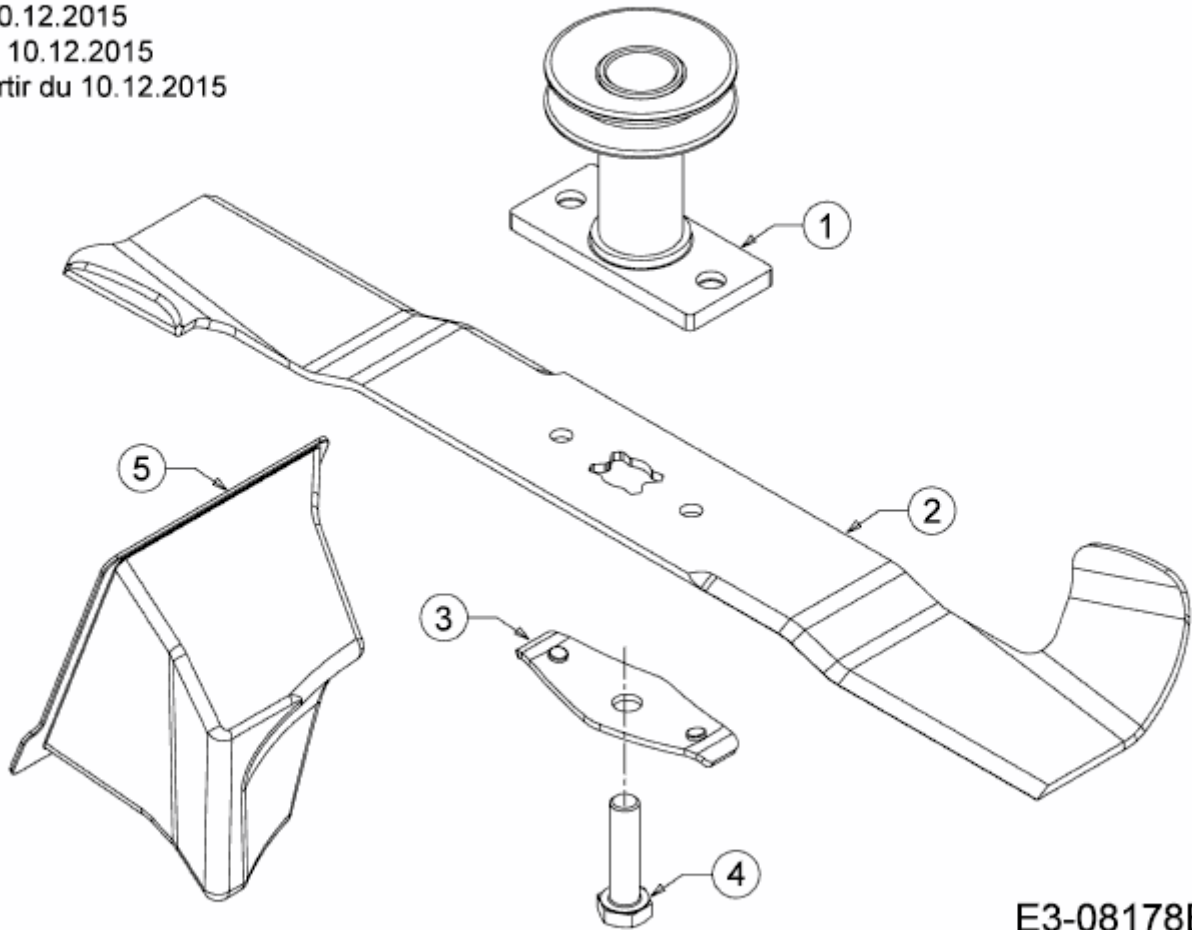

E3-08178B-02