

AMBITION 475 A > 12ABC55Z650 (2012) > MESSER, RÄDER, SCHNITTHÖHENVERSTELLUNG, GETRIEBE

AMBITION 475 A

12ABC55Z650

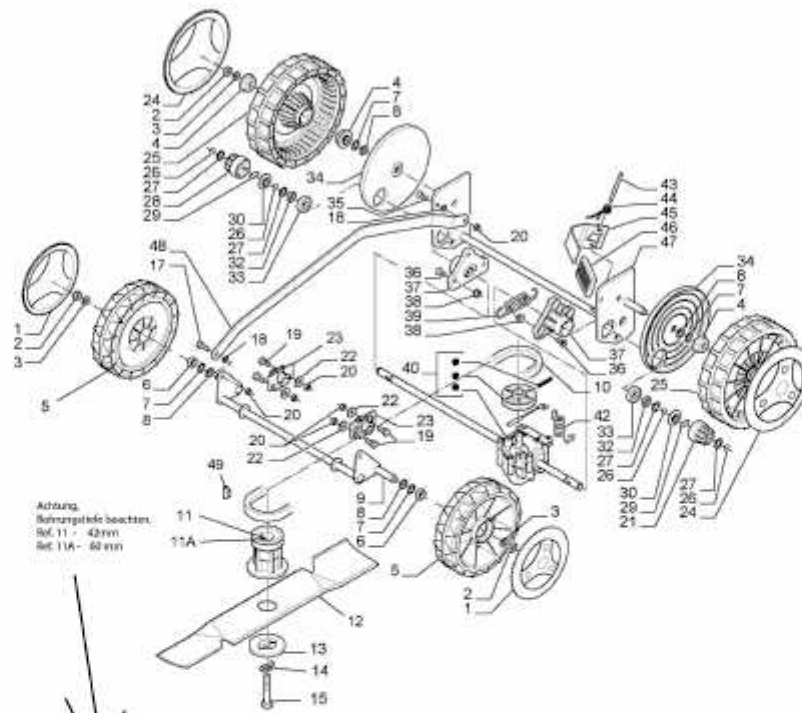

Achtung.
Bohrungstiefe beachten.
Ref. 11 - 42mm
Ref. 11A - 60mm

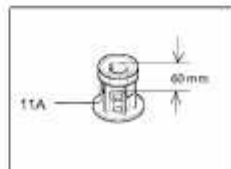
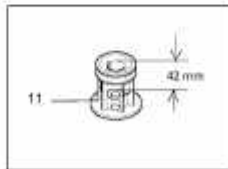

E3-07674A-01