

**196-715-678**

**MULCH KIT ALU-MÄHER / KIT MULCHING**

**51 cm**

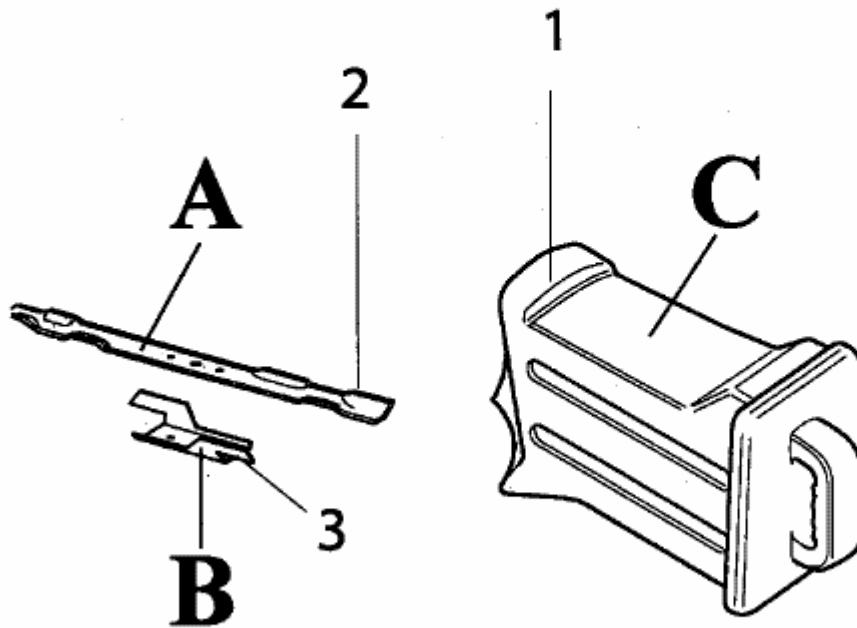

**E4-01322A**