

GE 53 AK > 12A-Y77D678 (2003) > KURBELGEHÄUSE, ZYLINDER

Kawasaki-Motor FH 180 MTD-Nr. 752S180S50

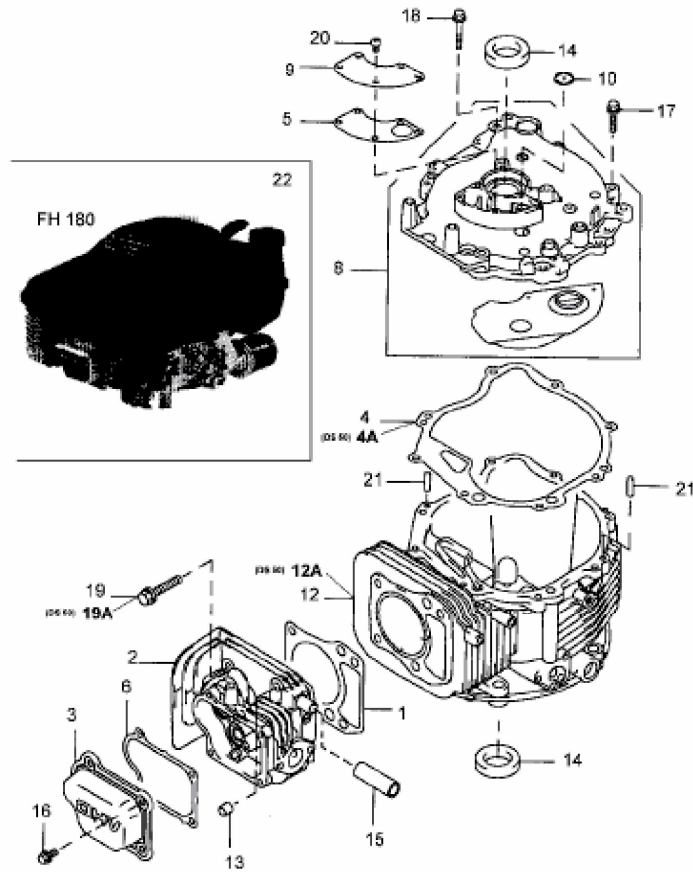

E3-01801A