

Kawasaki-Motor FH180

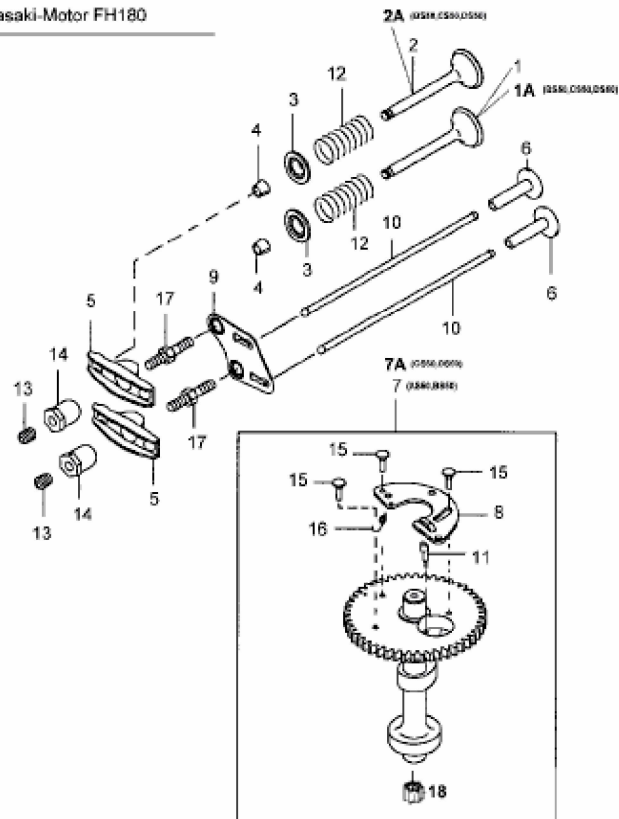

E3-01803A