

OPTIMA 46 SPHHW > 12A-TH9Q600 (2016) > MESSER, MESSERAUFNAHME,
MULCHSTOPFEN

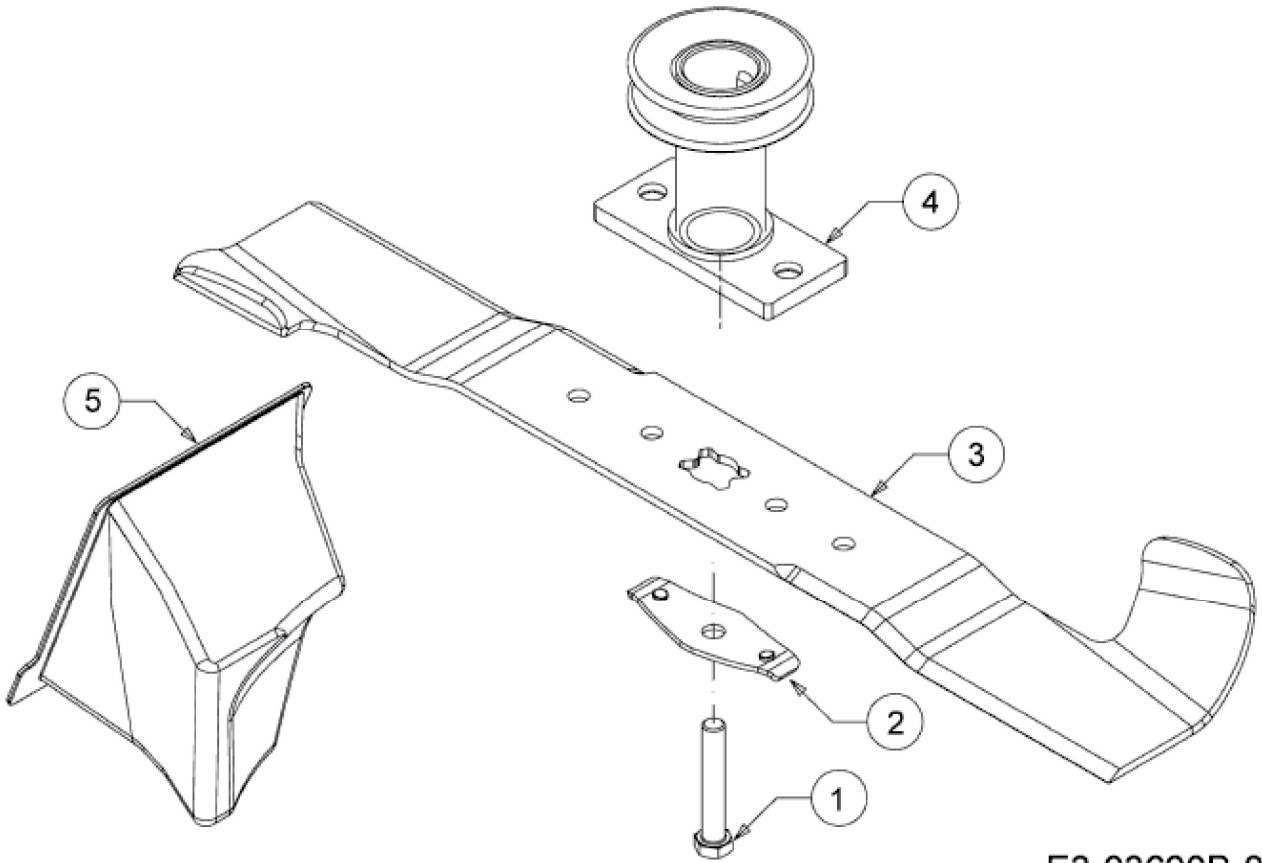

E3-03620B-01