

OPTIMA 46 SPBHW > 12A-TH5C600 (2015) > MESSER, MESSERAUFNAHME,
MULCHSTOPFEN

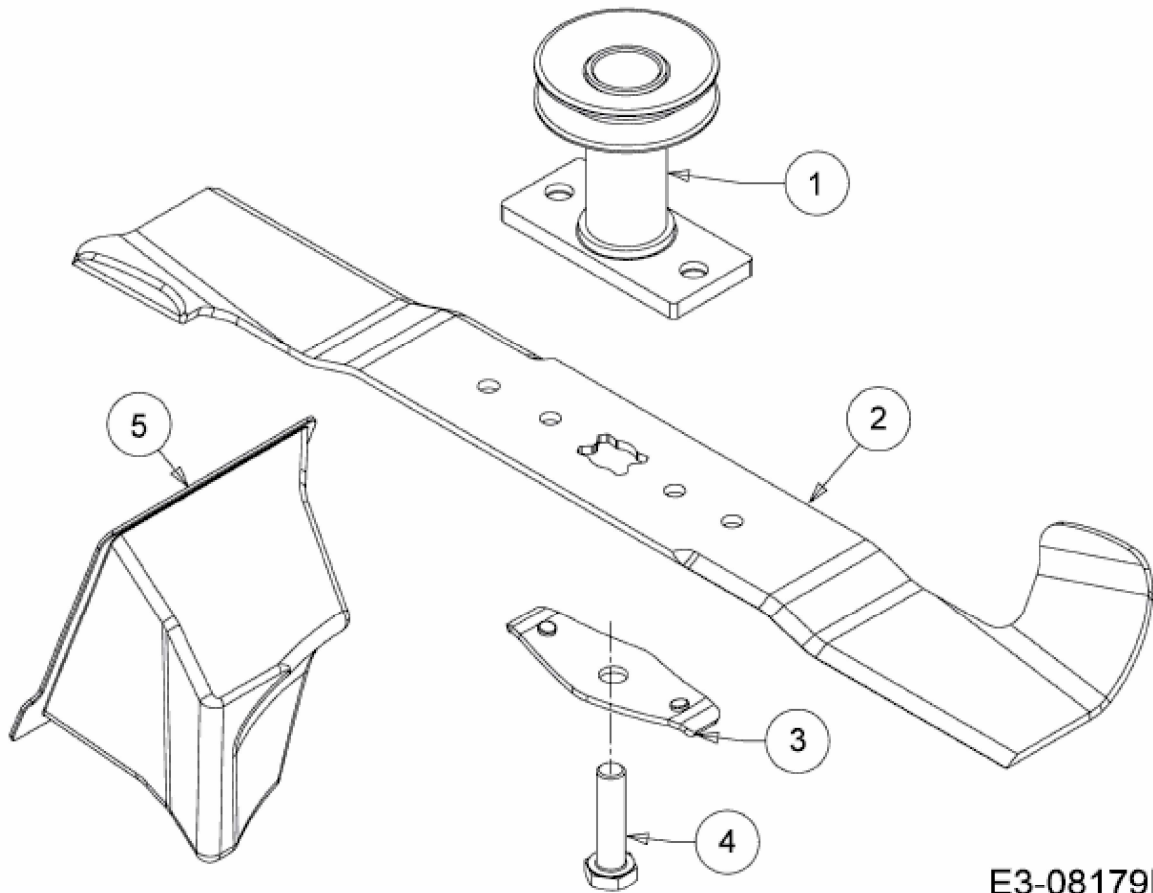

E3-08179B-01