

ab 19.12.2015  
from 19.12.2015  
à partir du 19.12.2015

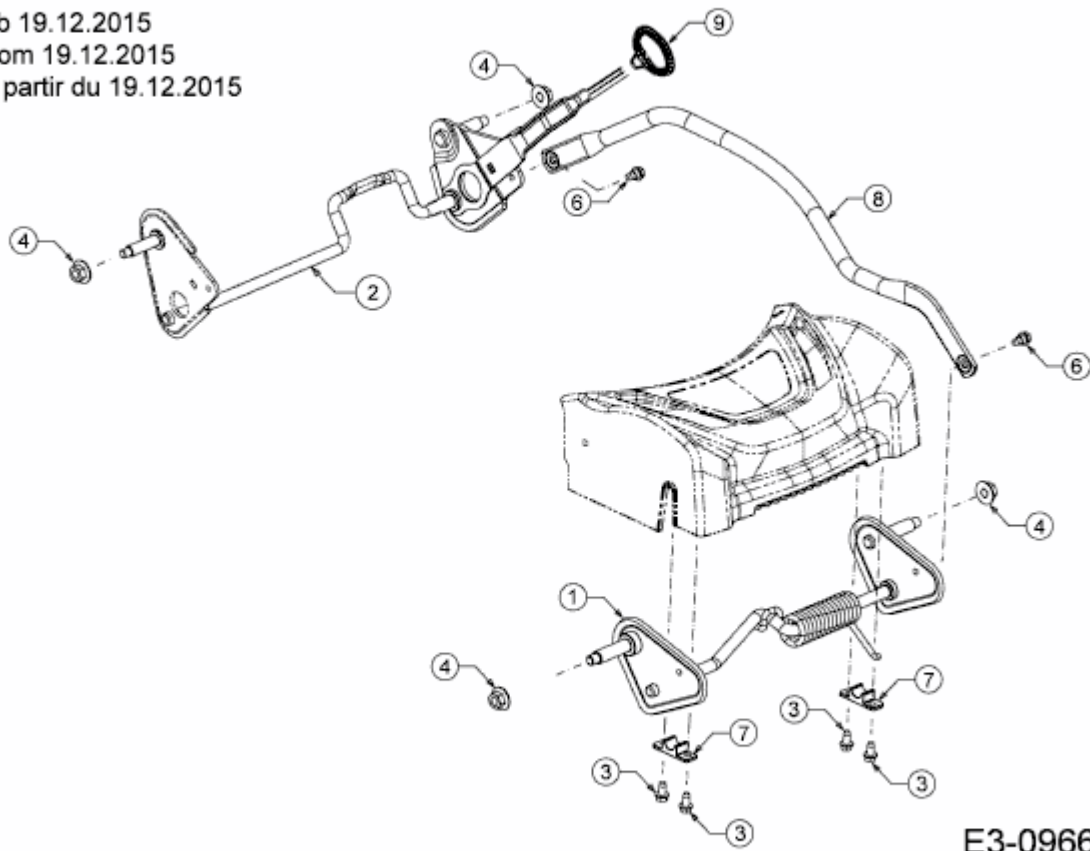

E3-09669A-02