

ab 10.03.2018
from 10.03.2018
à partir du 10.03.2018

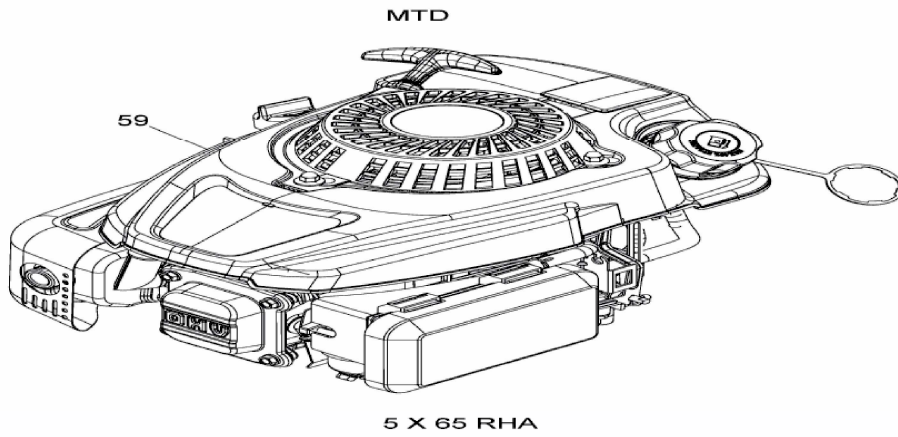

E3-00013A-02