

ADVANCE 53 SPKHW > 12A-PN7D600 (2015) > GRASFANGSACK, HECKKLAPPE, LEITSTÜCK  
HINTEN

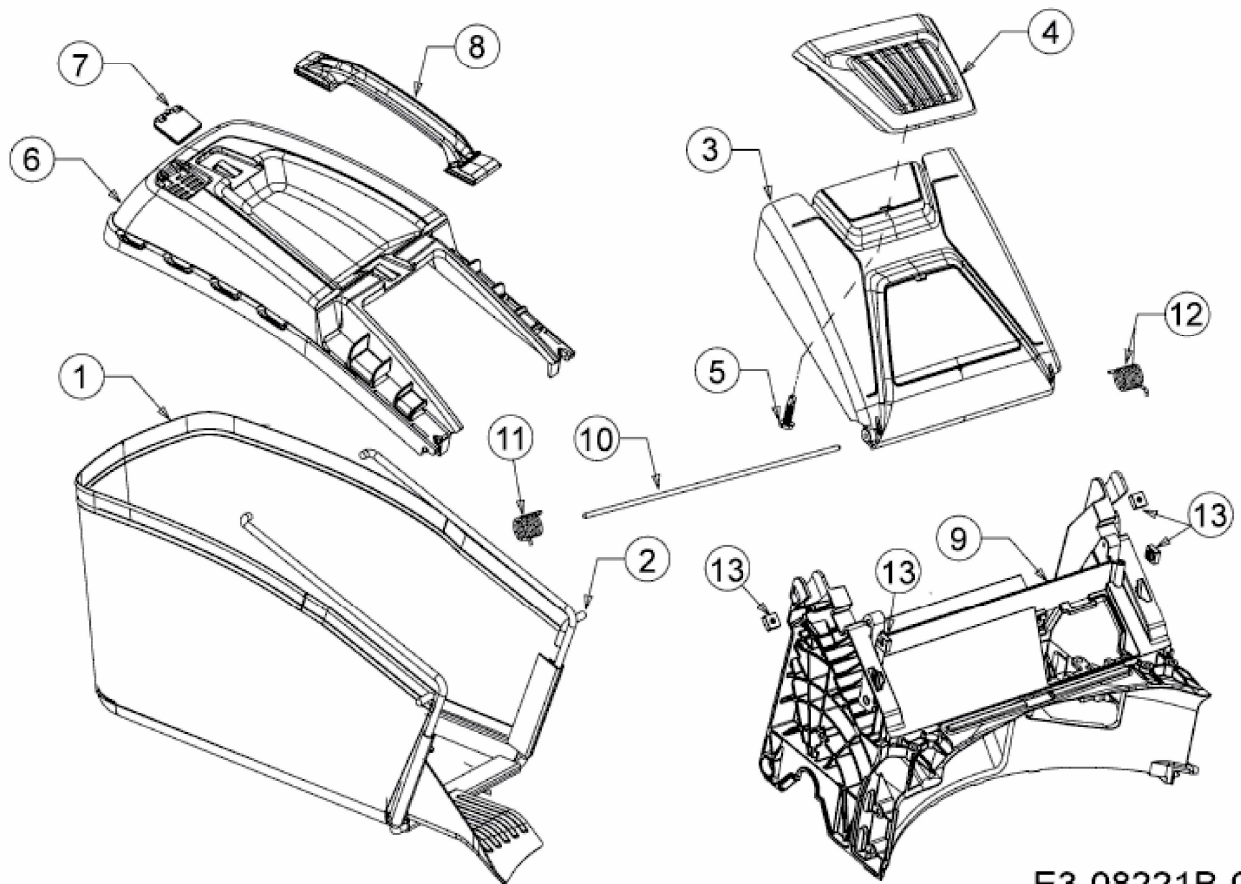

E3-08221B-01