

ab 22.01.2015
from 22.01.2015
à partir du 22.01.2015

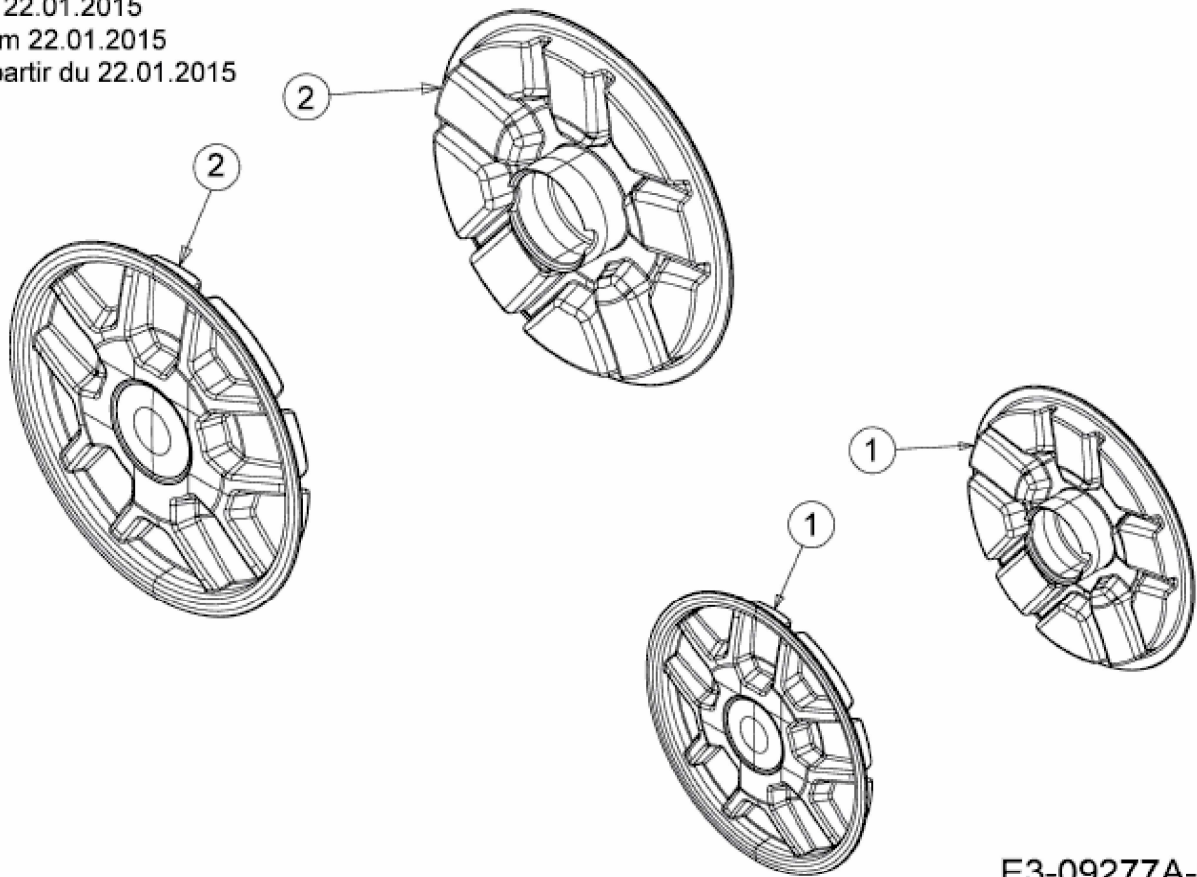

E3-09277A-01