

46 S > 12A-J7SJ600 (2017) > GETRIEBE, KEILRIEMEN

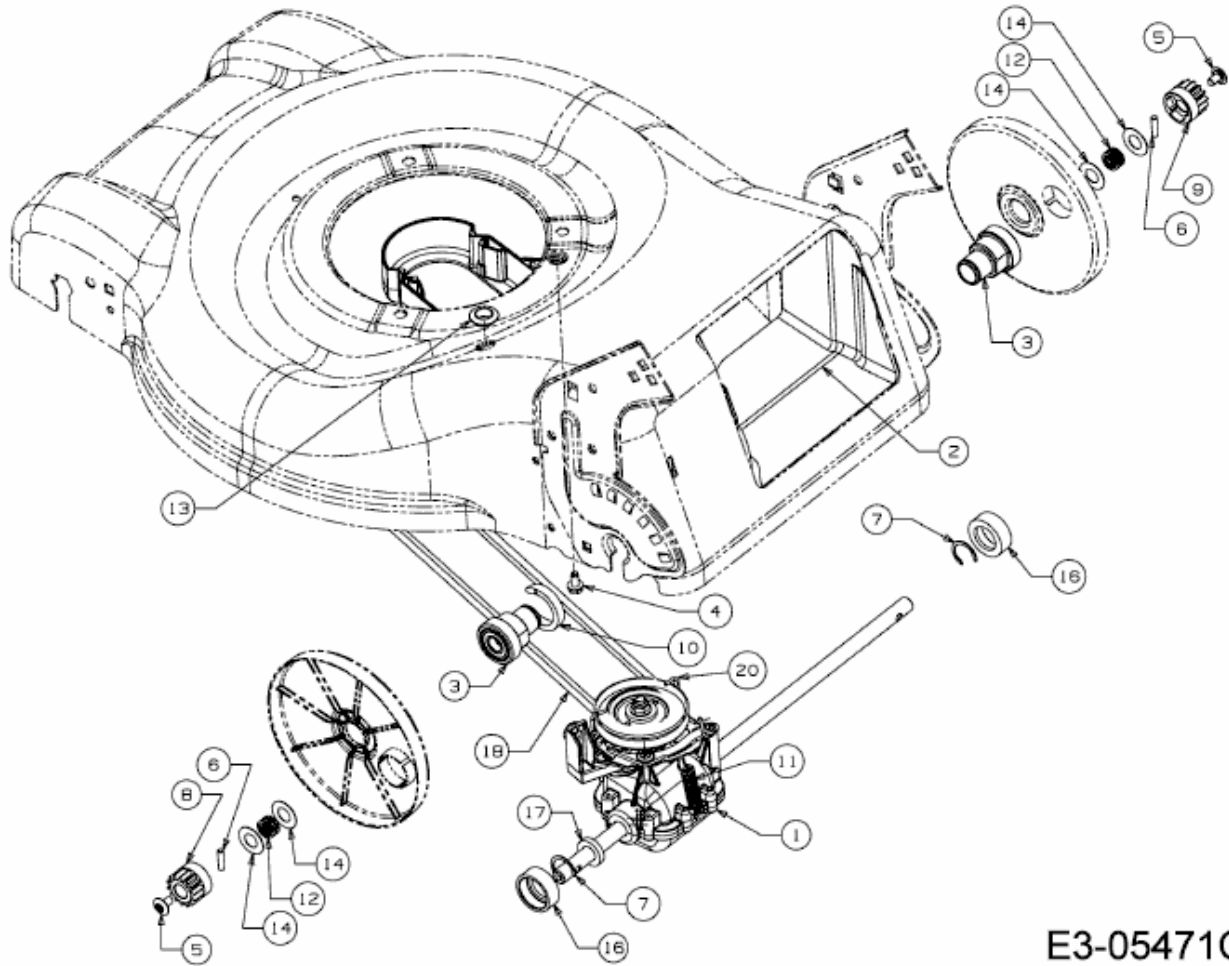

E3-05471C-01