

BLUE POWER 40 A > 12A-I45A650 (2013) > SCHNITTHÖHENVERSTELLUNG

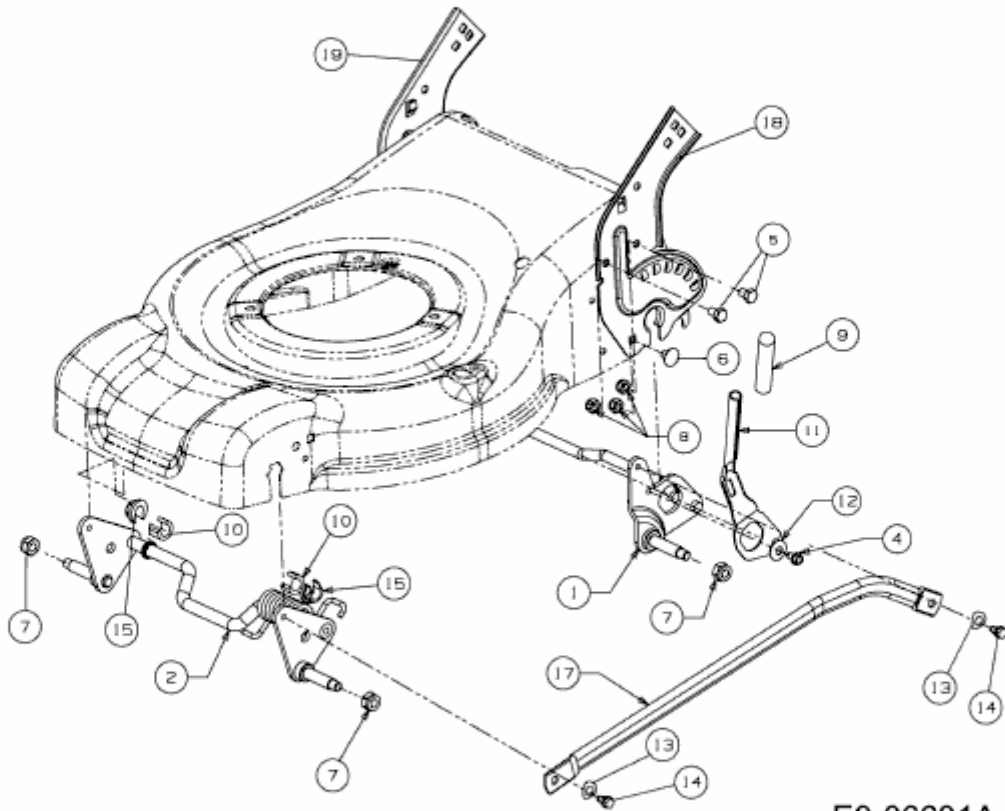

E3-06681A-01