

BLUE POWER 40 A > 12A-I45A650 (2012) > LEITBLECH VORN

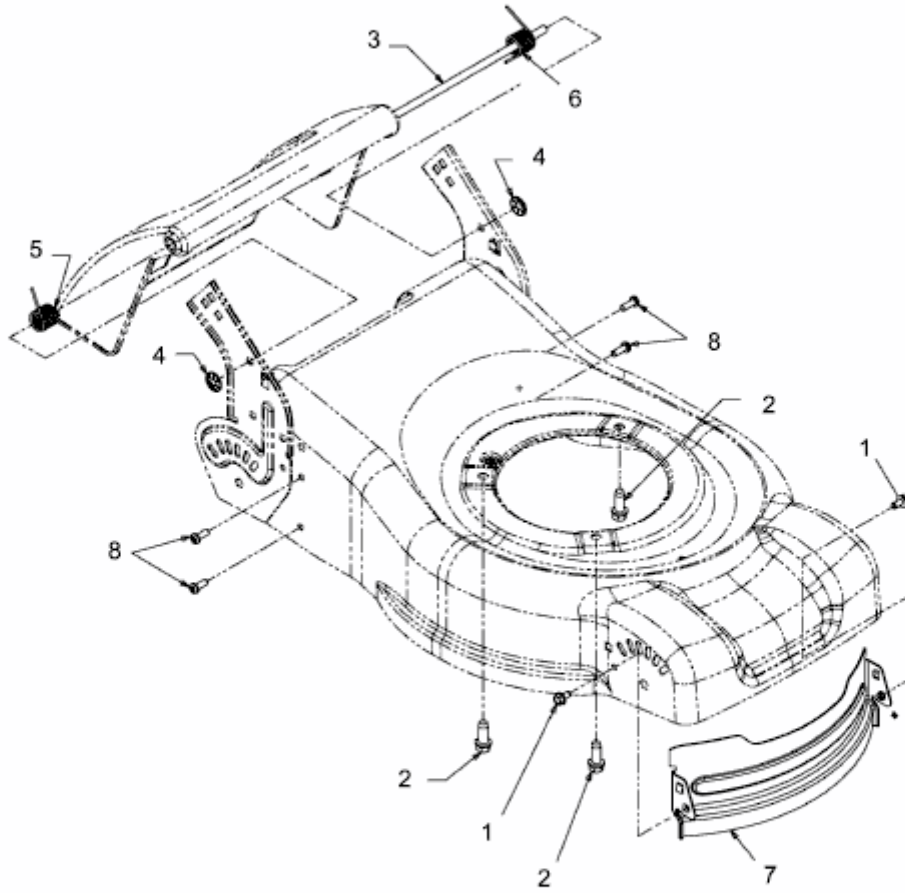

E3-05677A-01