

YM 6521 C > 12A-999L643 (2002) > GETRIEBE, MESSER, SCHNITTHÖHENVERSTELLUNG, RÄDER

YM 6521 C	12A-999L643
YM 6021 CS	12AS999T643
HB 58 RLC	12A-999I690
HB 58 RLCS	12AS999U690
CW 215	12A-999D679

Nicht abgebildet / not shown

MOTOR / ENGINE	
88A	YM 6521 C
88B	YM 6021 CS
89C	HB 58 RLC
89D	HB 58 RLCS
89D1	HB 58 RLCS
90	FINGERSCHUTZ / FINGER GUARD
91	AUSPUFFSCHUTZ / MUFFLER GUARD

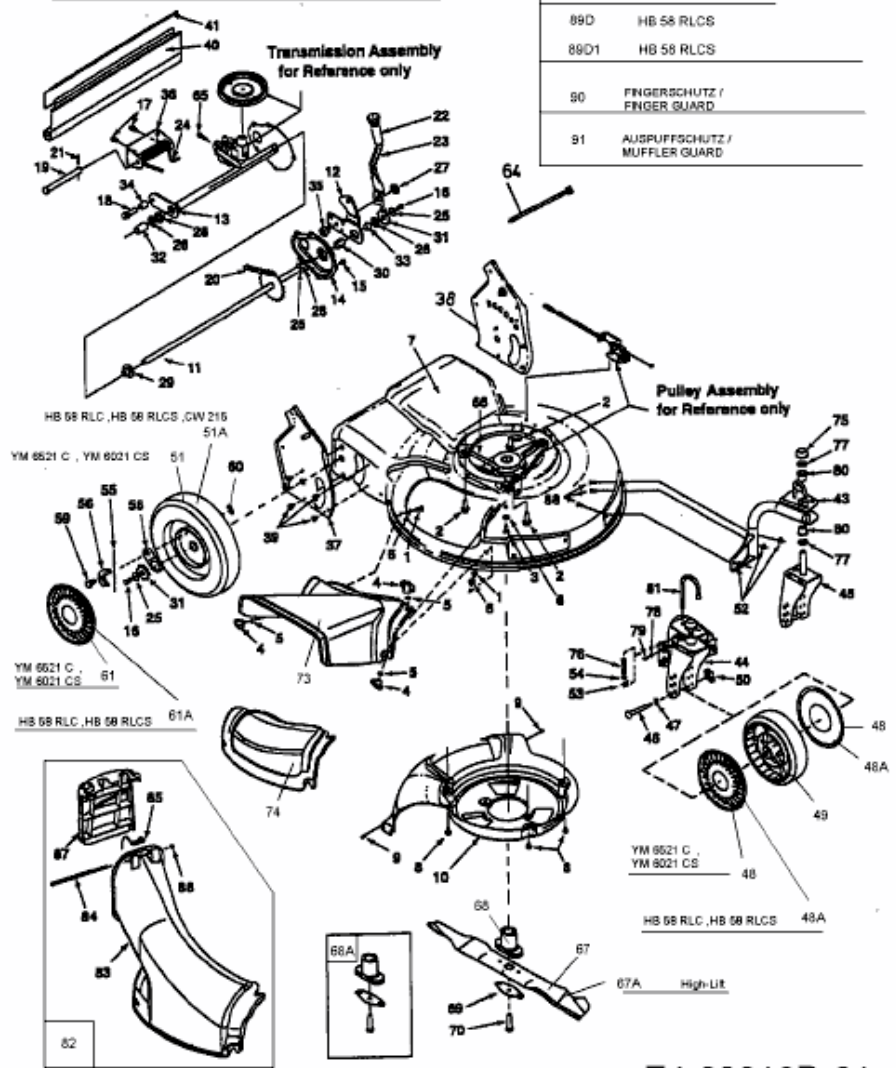

E4-00016D-01