

YM 6021 CB > 12A-999H643 (2011) > GESCHWINDIGKEITSREGELUNG

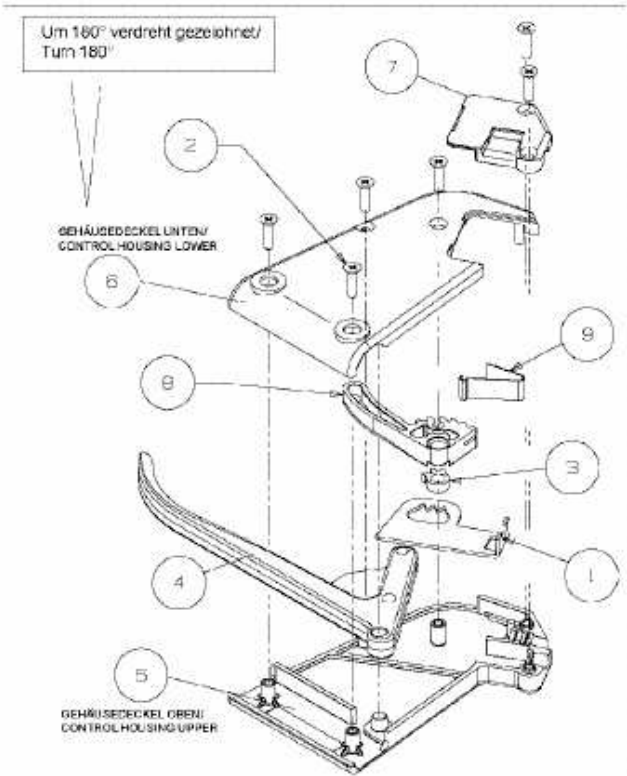
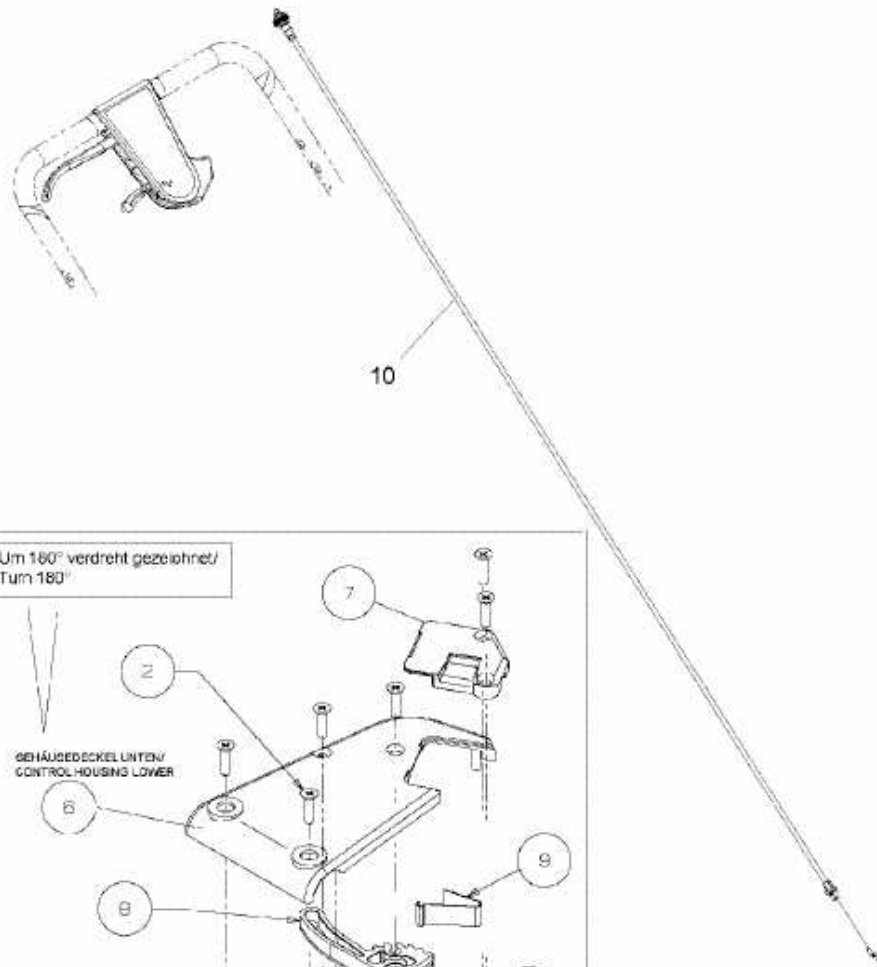

E3-02932A-01