

MF 21 SE > 12A-997D695 (2007) > RADTRÄGER VORN

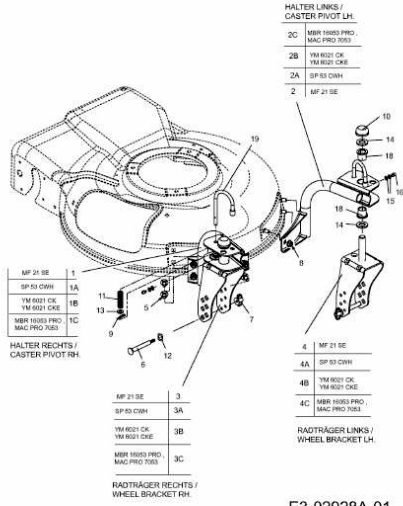

E3-02928A-01