

YM 6021 CK > 12A-997D643 (2009) > GESCHWINDIGKEITSREGELUNG

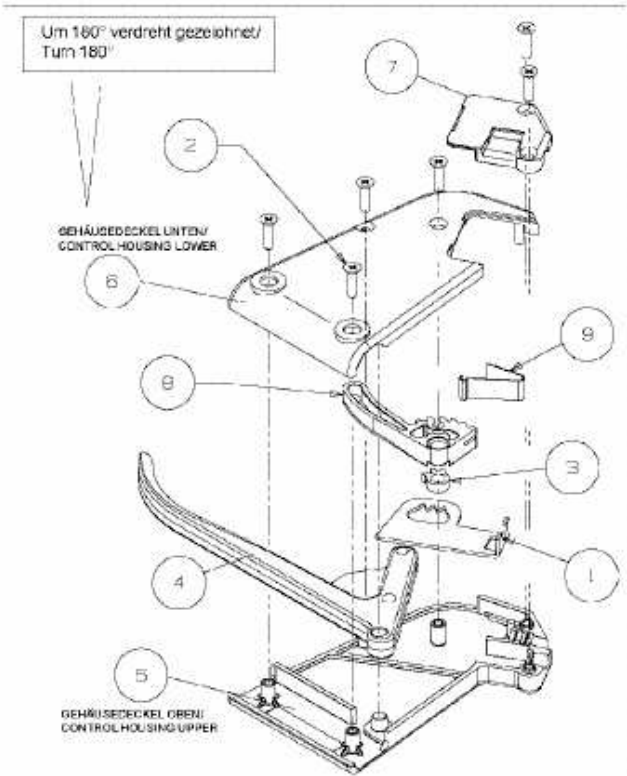
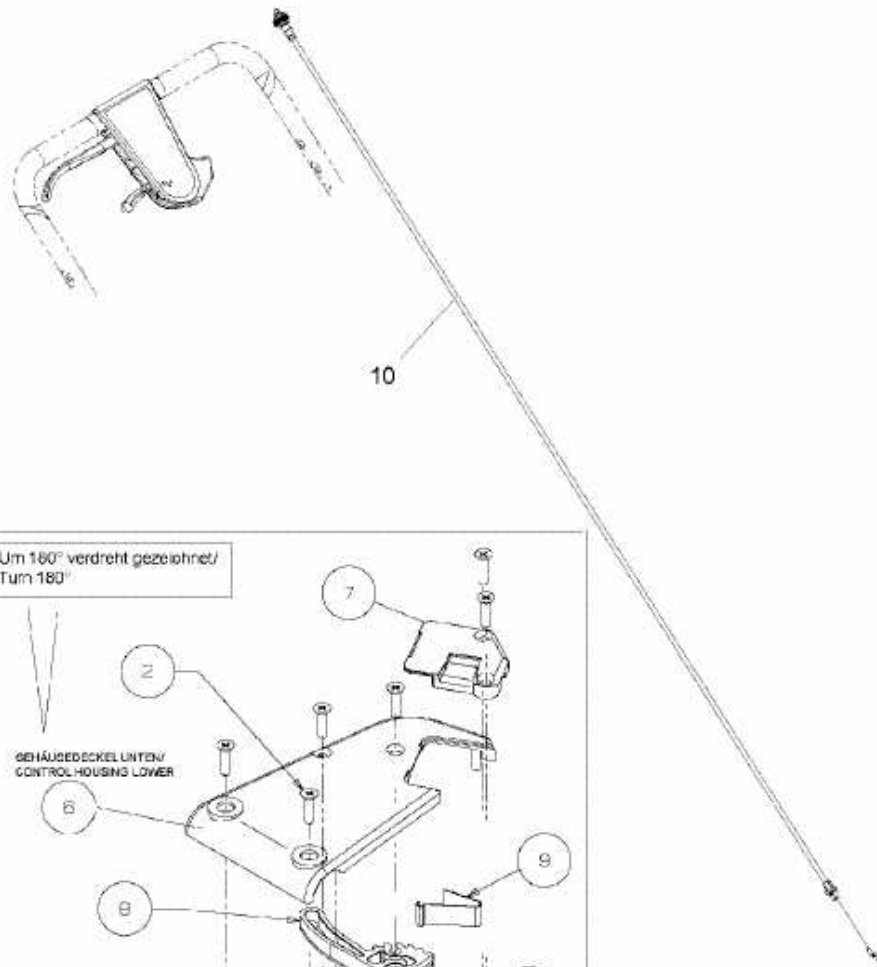

E3-02932A-01