

YM 6021 CK > 12A-997D643 (2008) > GESCHWINDIGKEITSREGELUNG

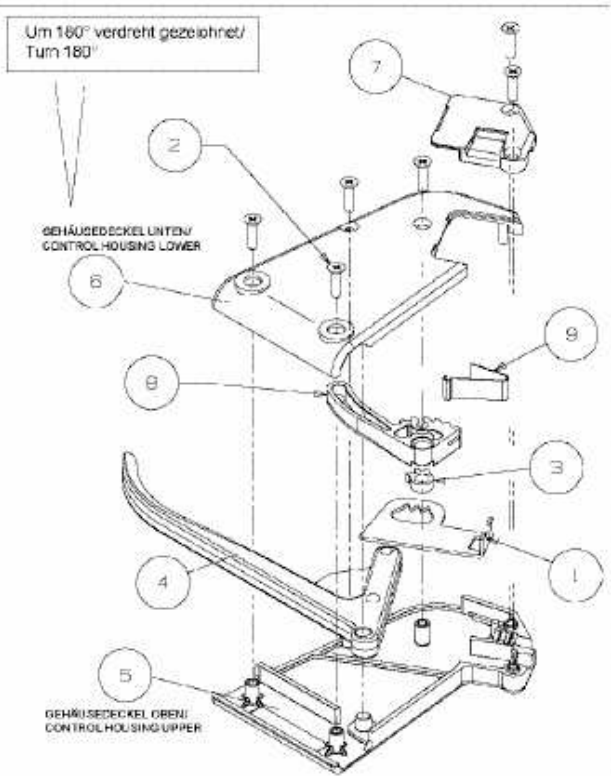
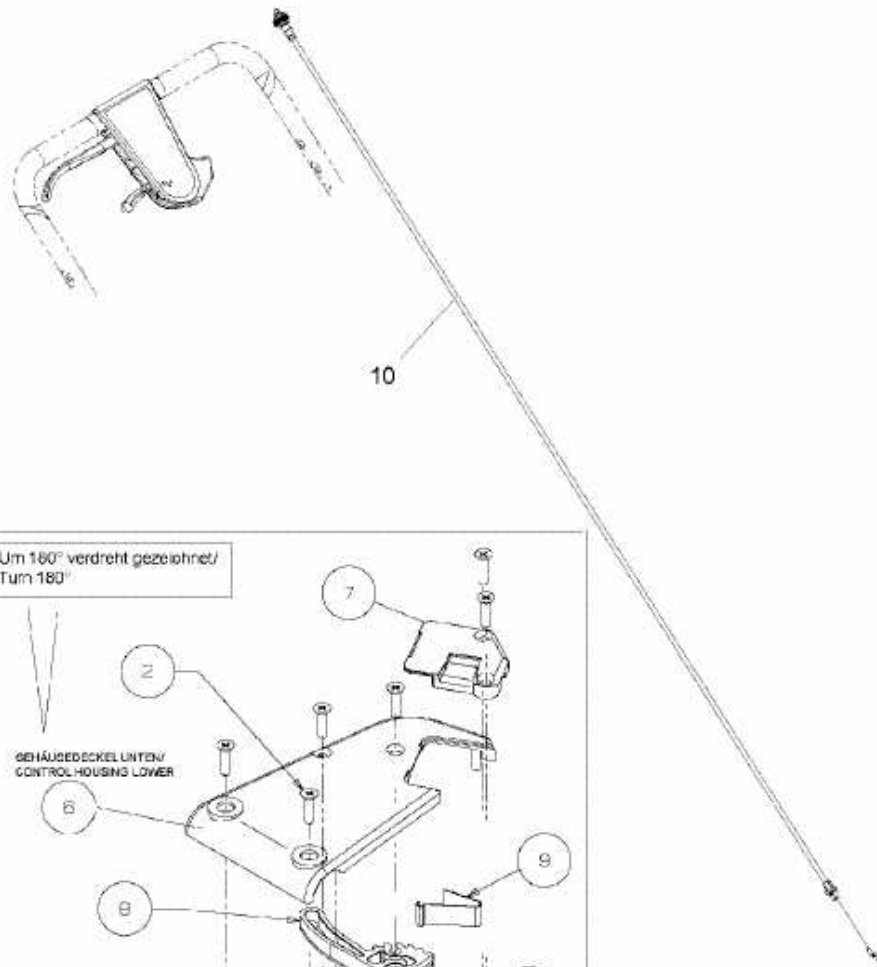

E3-02932A-01