

YM 6021 CK > 12A-997D643 (2004) > KURBELGEHÄUSE, ZYLINDER

Kawasaki-Motor FH 180 MTD-Nr. 752S180S50

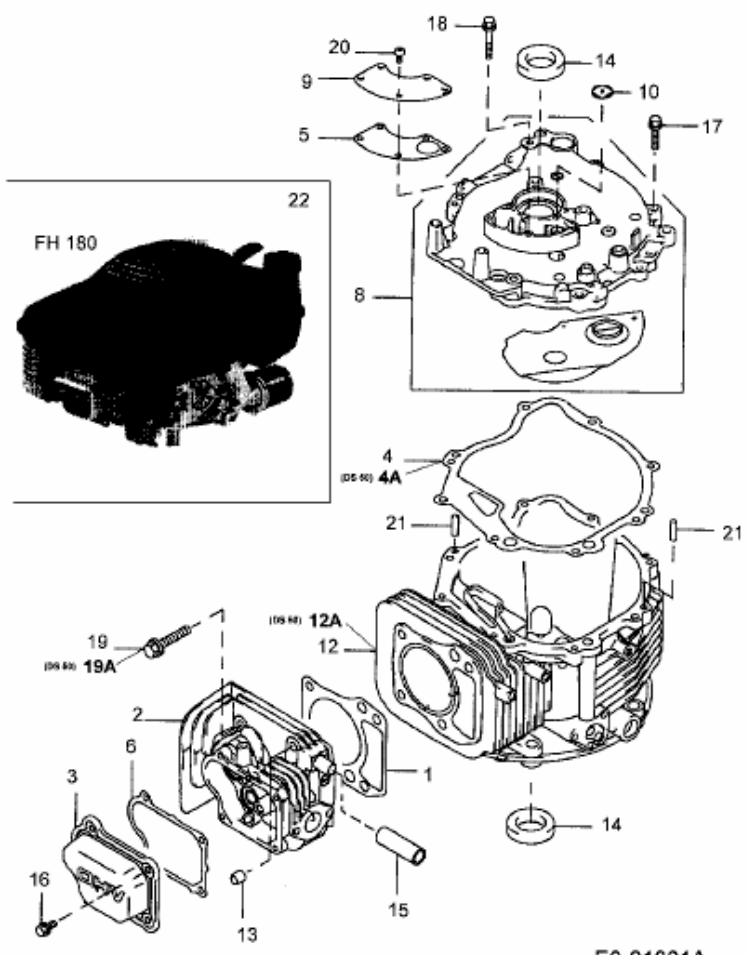

E3-01801A