

53 SPKHW > 12A-867D600 (2013) > SCHNITTHÖHENVERSTELLUNG

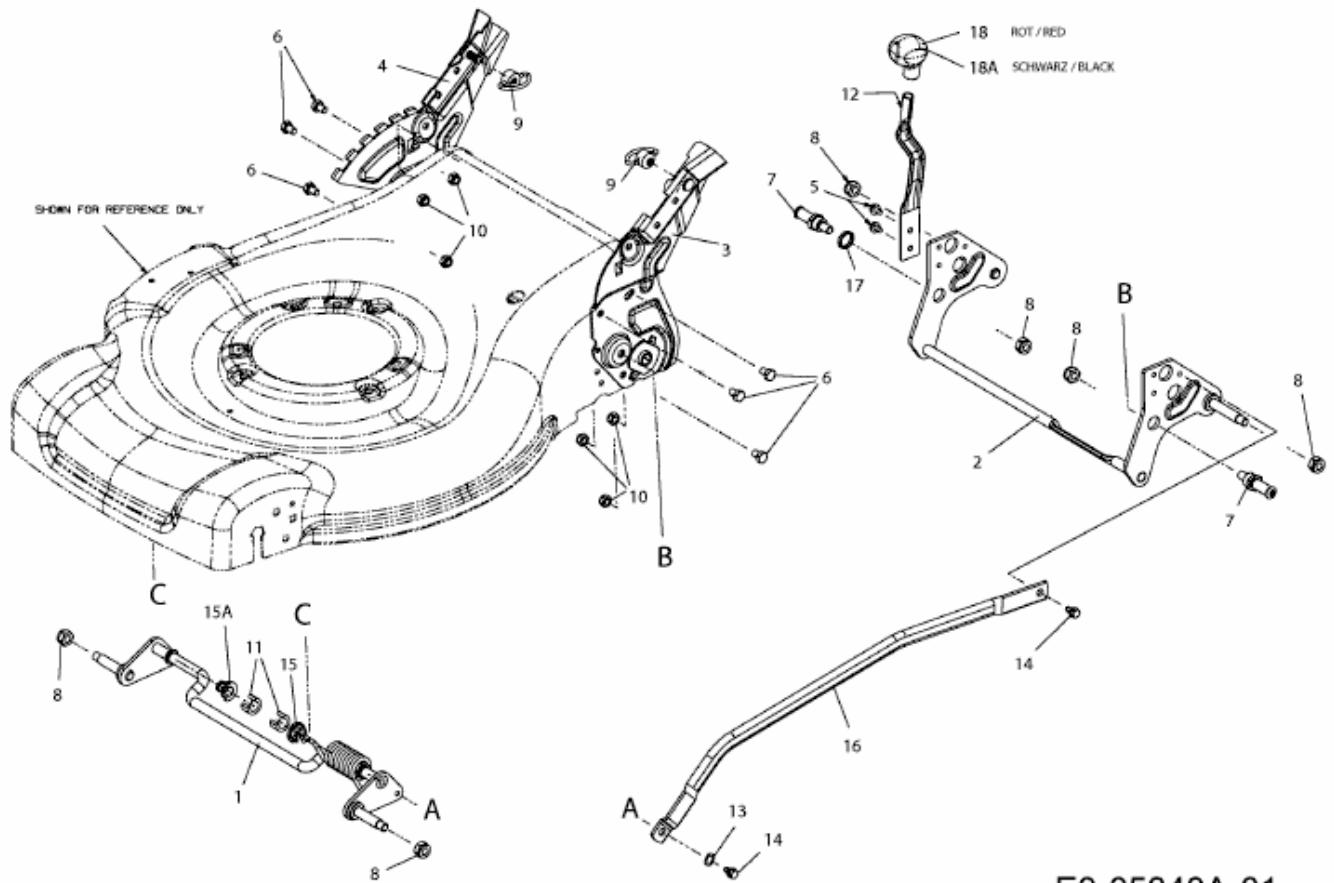

E3-05340A-01