

53 SPHWMH > 12A-85FQ676 (2013) > SCHNITTHÖHENVERSTELLUNG

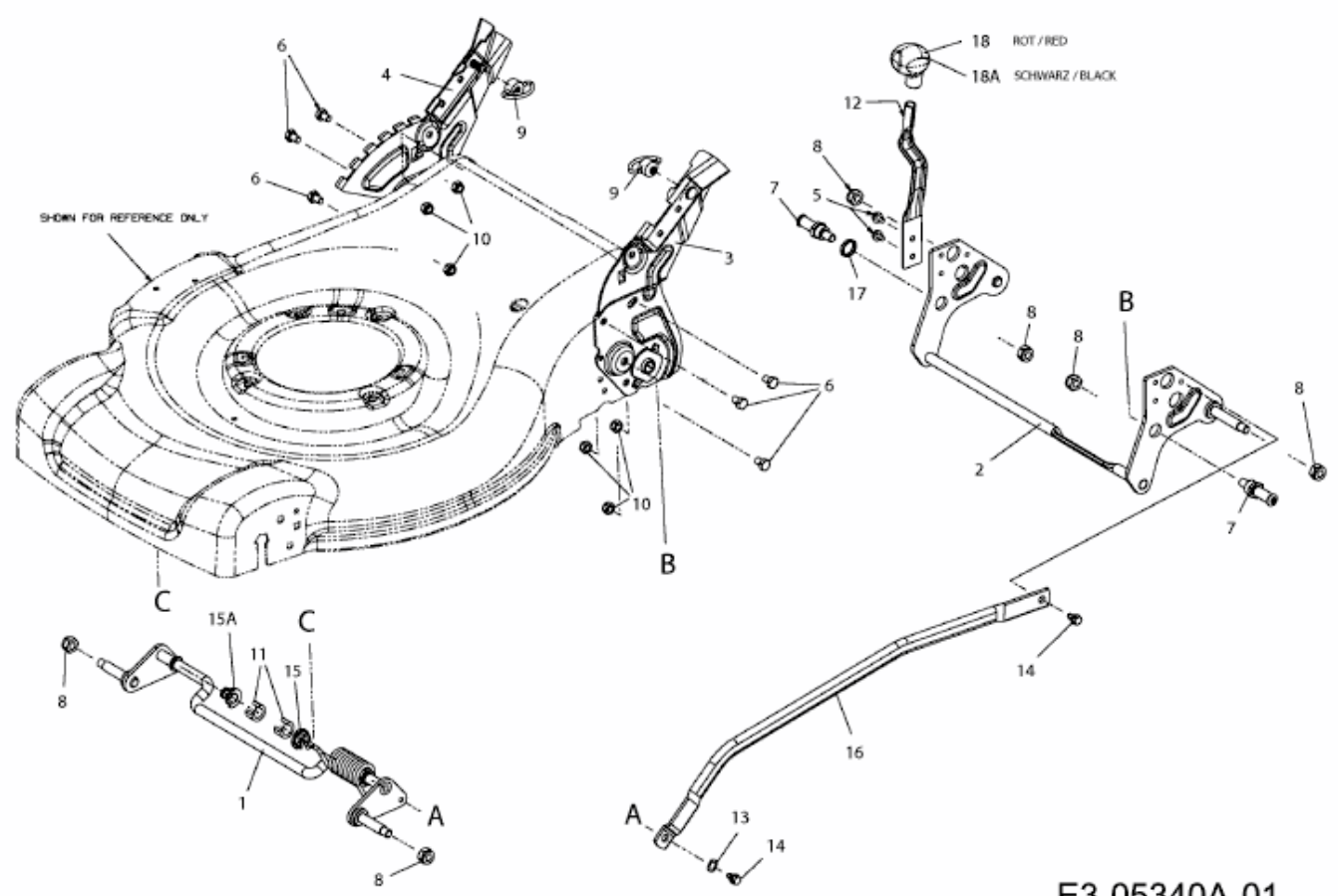

E3-05340A-01