

HWD 5553 TH > 12A-85CQ629 (2013) > SCHNITTHÖHENVERSTELLUNG

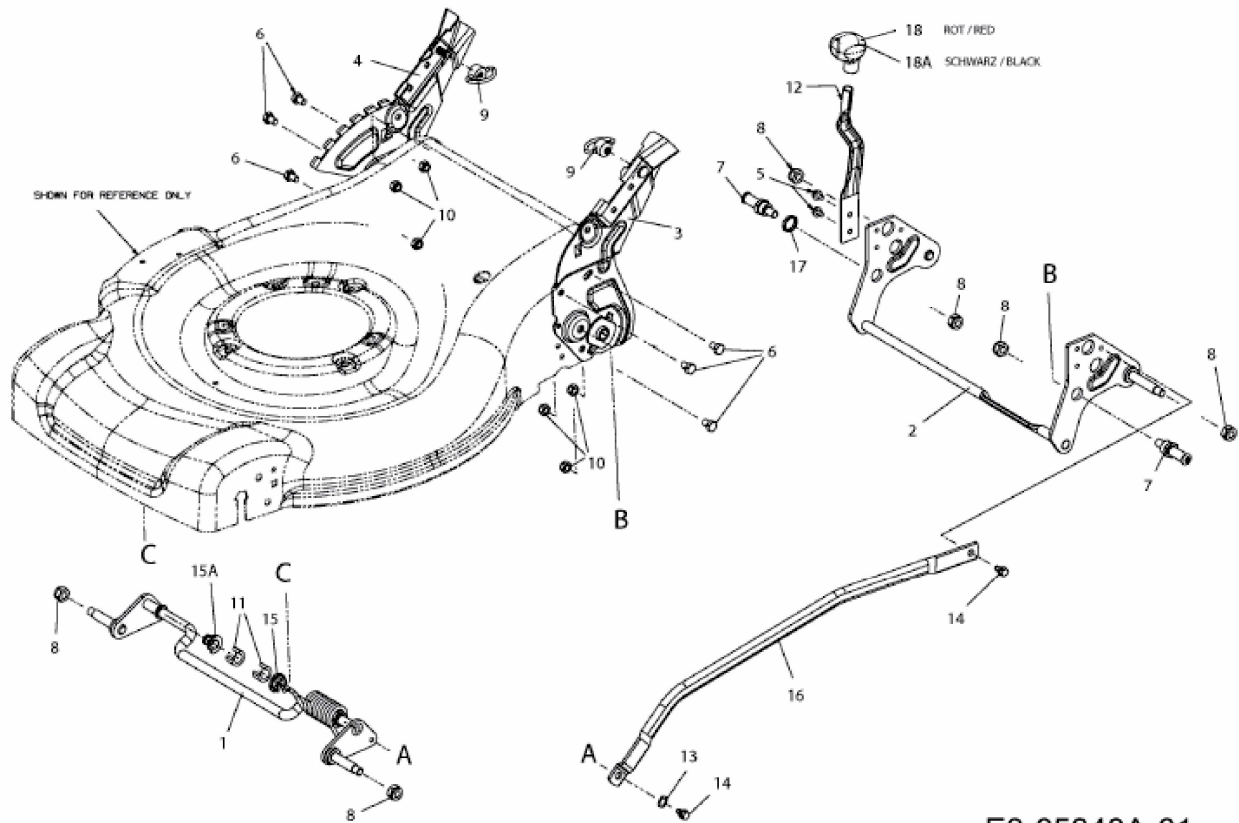

E3-05340A-01