

53 S > 12A-84J6600 (2016) > GETRIEBE, KEILRIEMEN

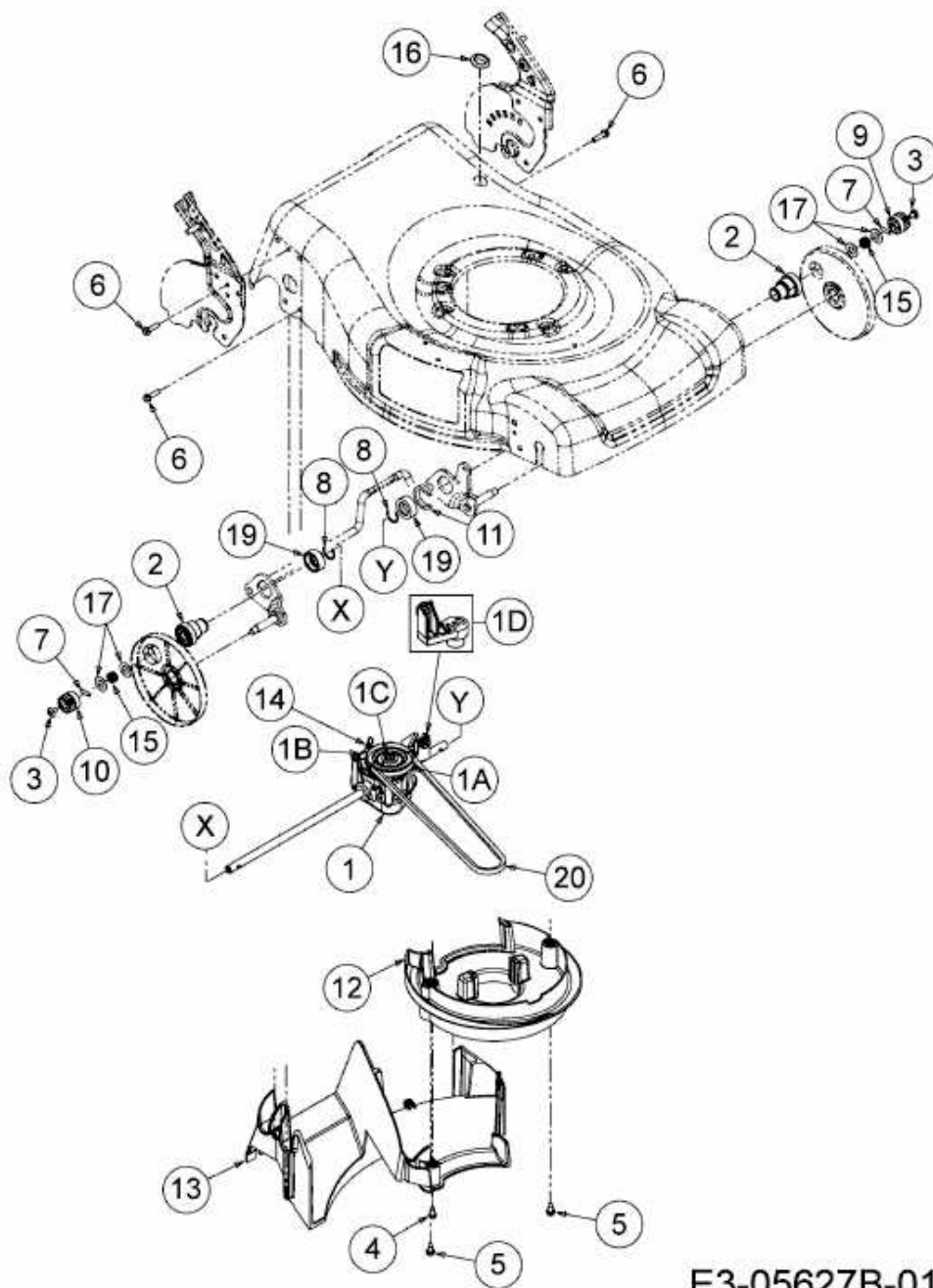

E3-05627B-01