

53 S > 12A-84J6600 (2016) > MÄHWERKSGEHÄUSE, STANGE FÜR HECKKLAPPE

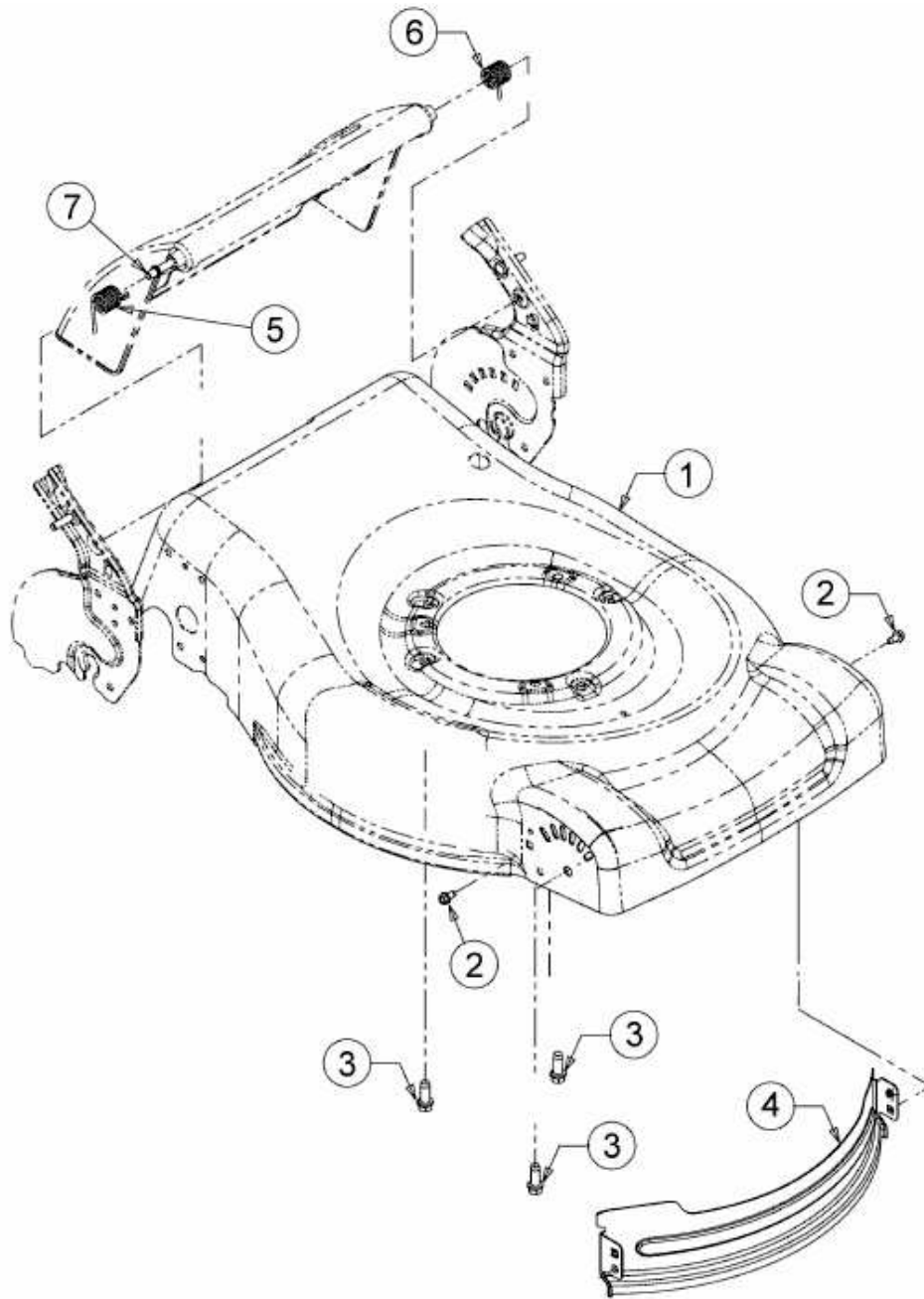

E3-05643B-01