

46 PHM-HQ > 11D-J1AQ616 (2012) > SCHNITTHÖHENVERSTELLUNG

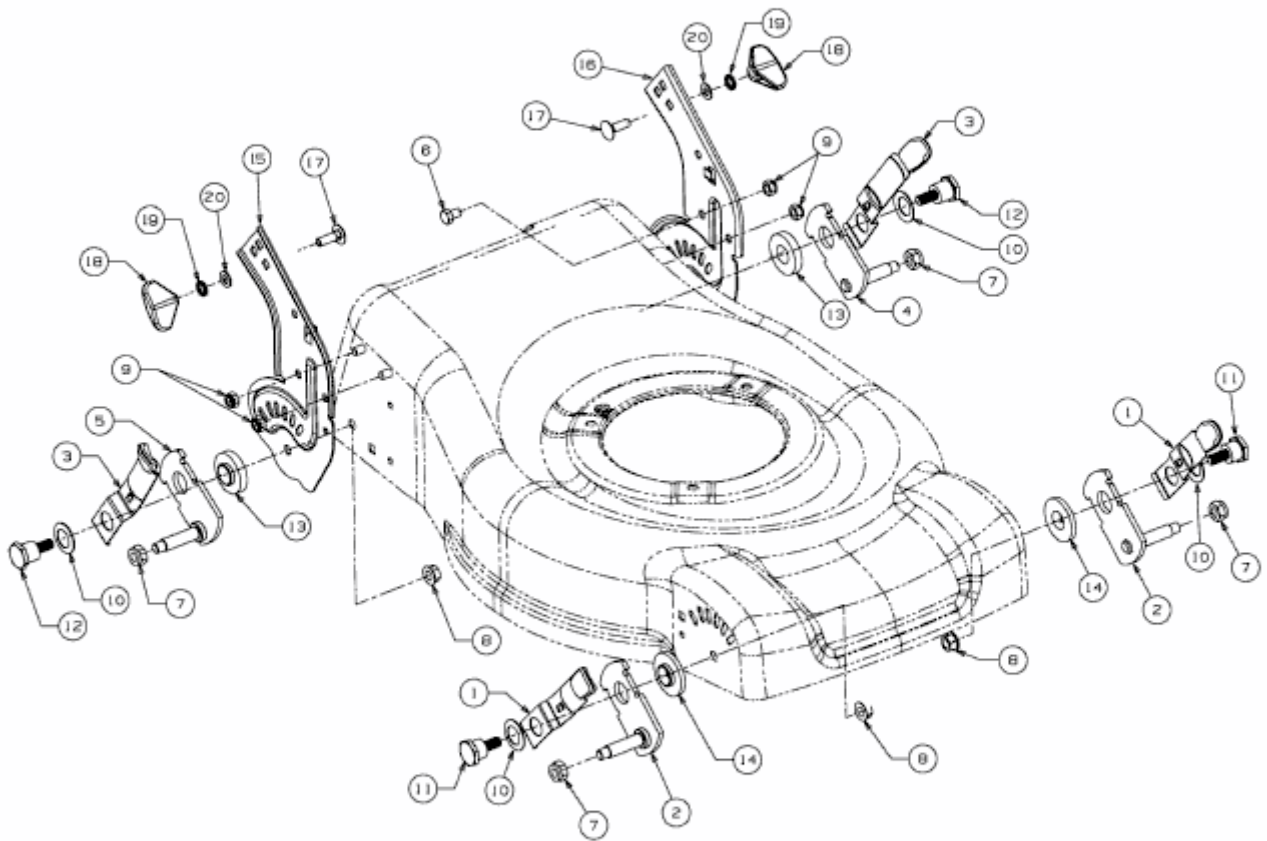

E3-04793A-01