

46 PHM-HQ > 11D-J1AQ616 (2011) > HOLM

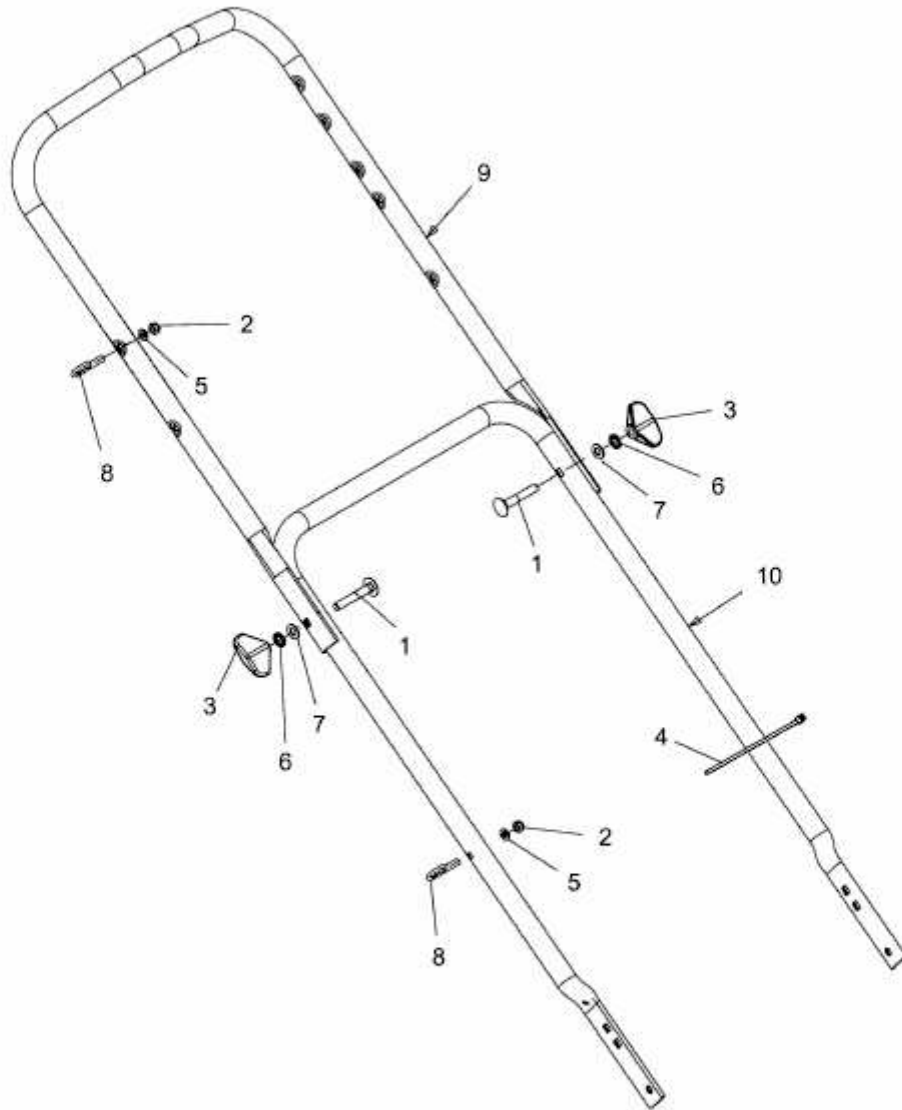

E3-05808A-01