

CC 46 MB > 11D-700G603 (2013) > HOLMBEFESTIGUNG

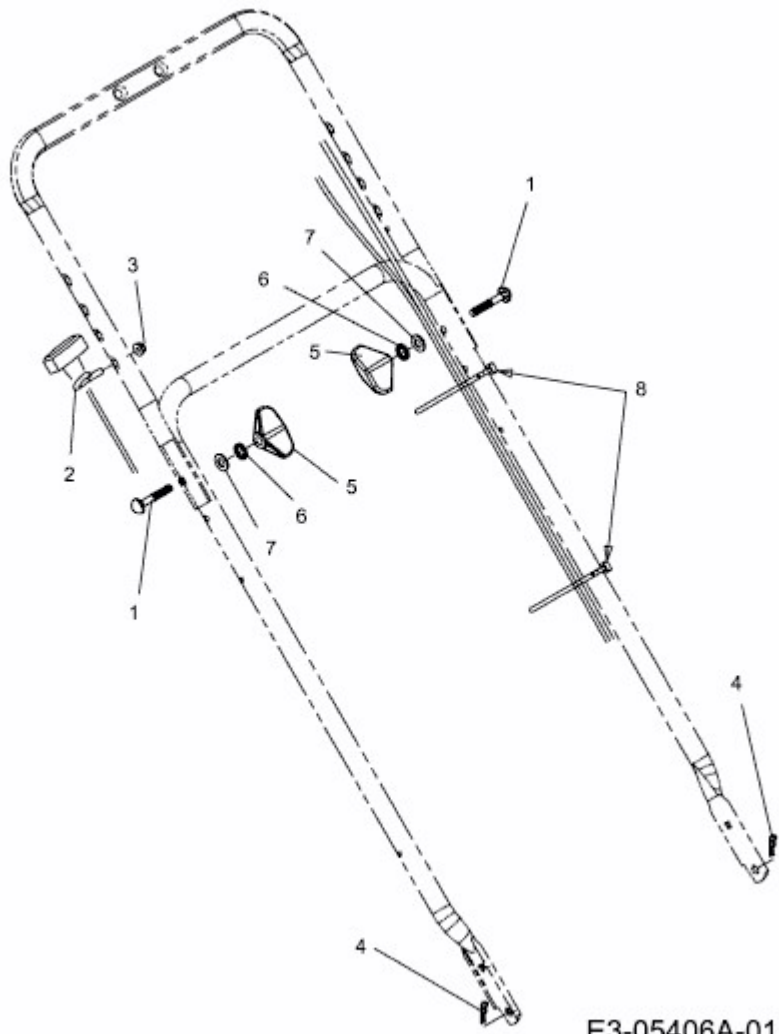

E3-05406A-01