

11C-J60G620 (2011) > SCHNITTHÖHENVERSTELLUNG

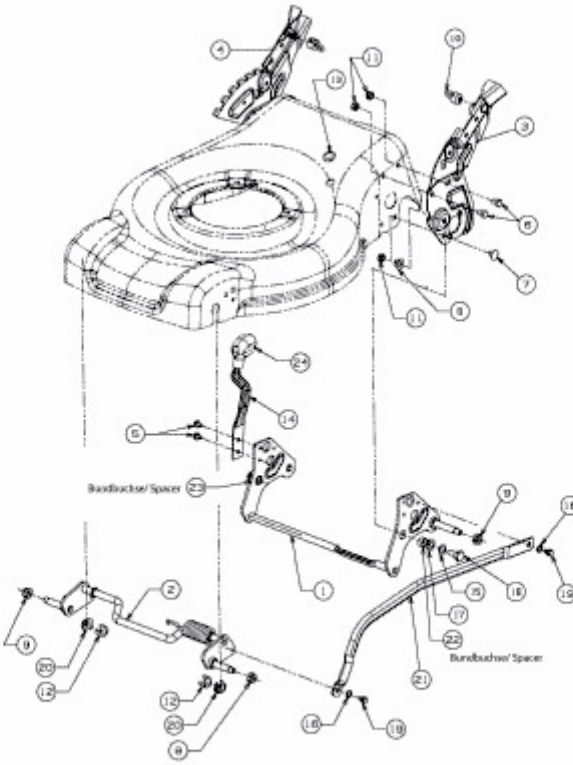

E3-05811A-01