

46 PO > 11C-J1JD676 (2012) > GRASFANGSACK, HECKKLAPPE

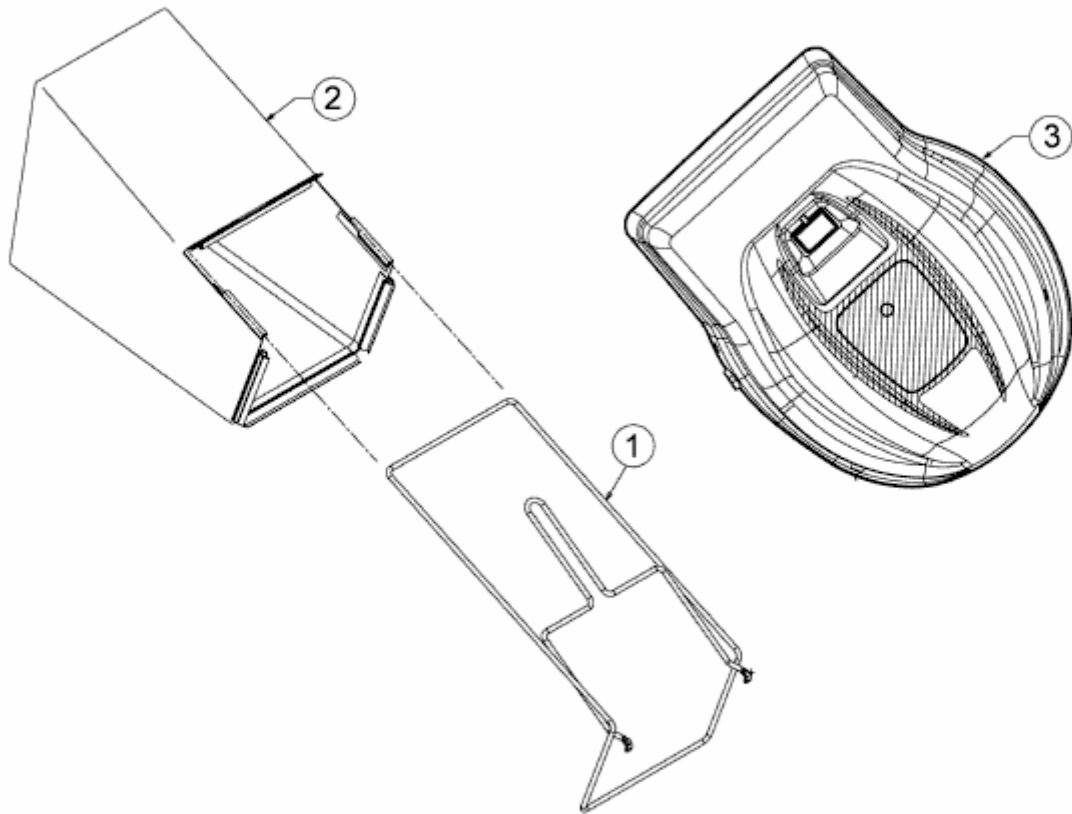

E3-05481A-01