

46 PO > 11C-J1JD676 (2012) > SCHNITTHÖHENVERSTELLUNG

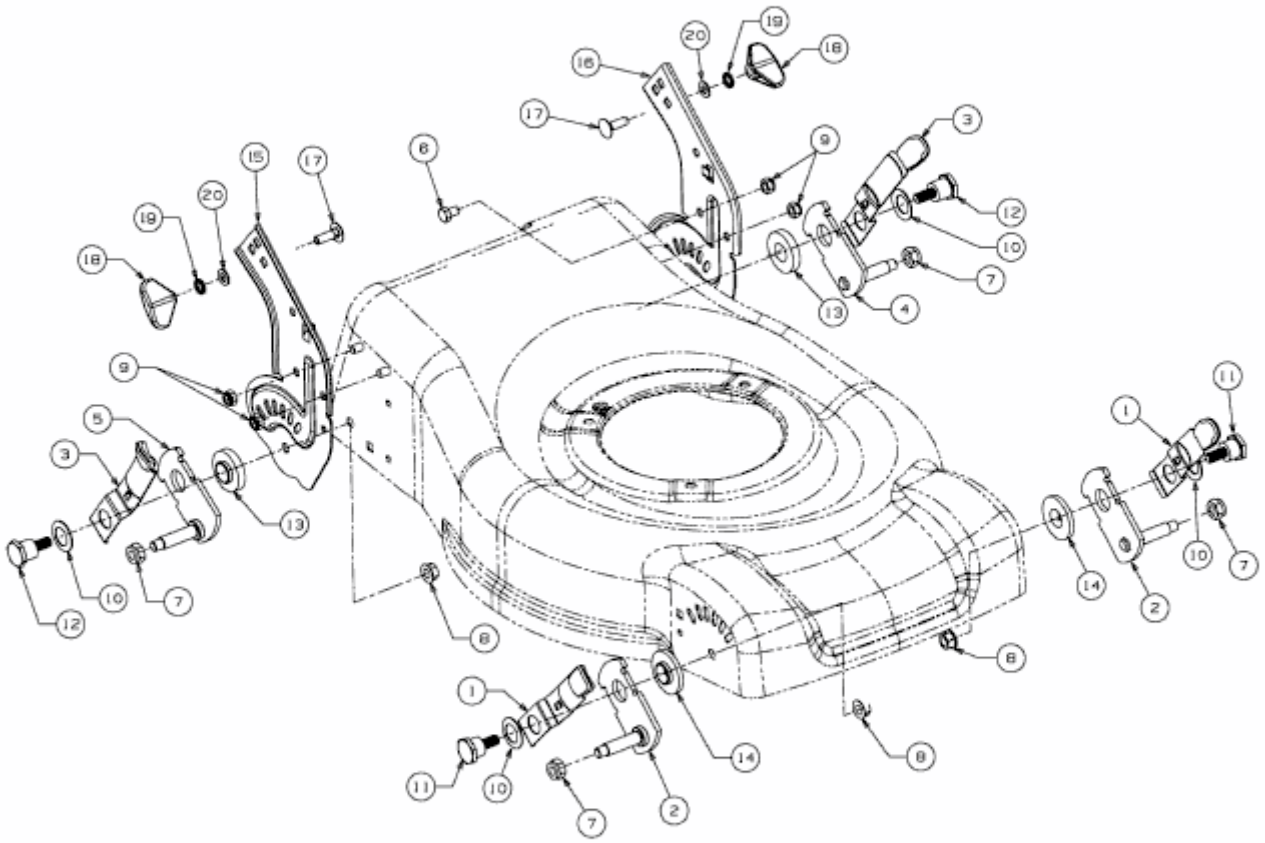

E3-04793A-01