

46 PO > 11C-J1JD600 (2010) > SCHNITTHÖHENVERSTELLUNG

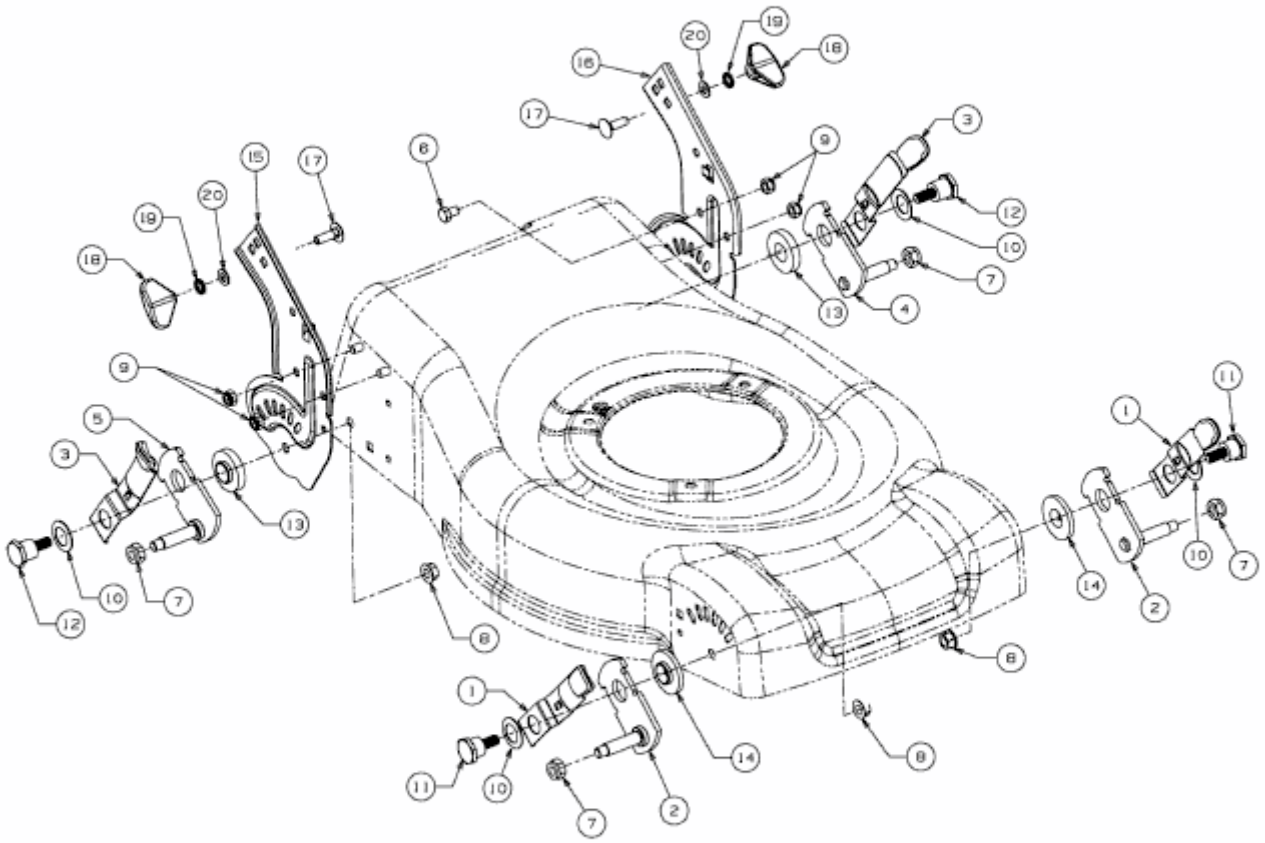

E3-04793A-01