

BL 4046 > 11C-J10G683 (2013) > GRASFANGSACK, HECKKLAPPE

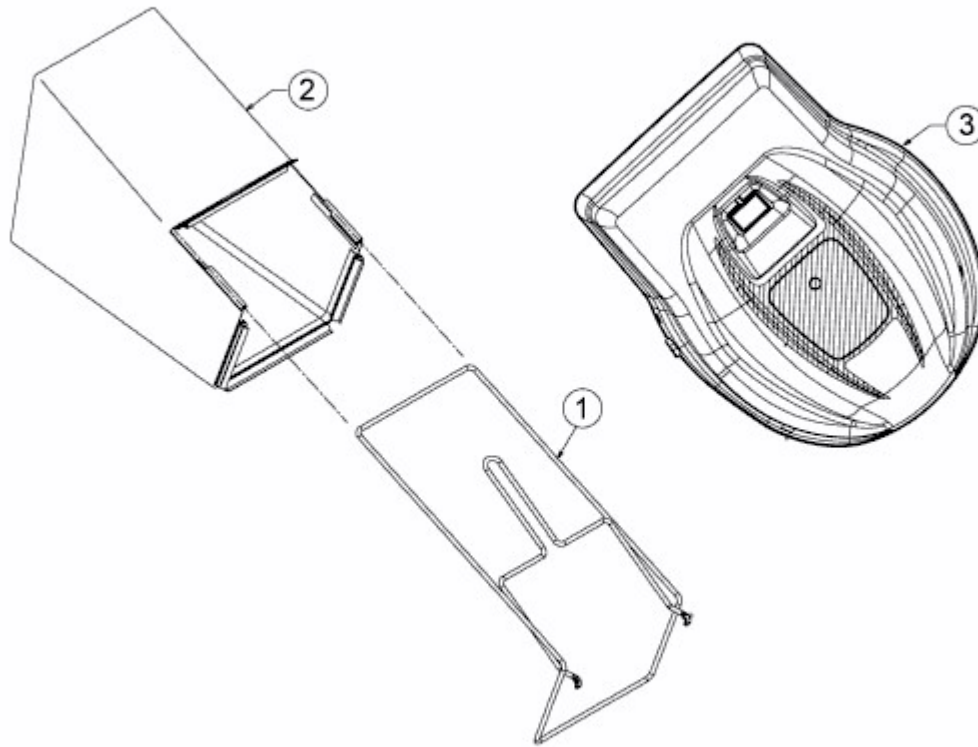

E3-05481A-01