

BL 4046 > 11C-J10G683 (2013) > SCHNITTHÖHENVERSTELLUNG

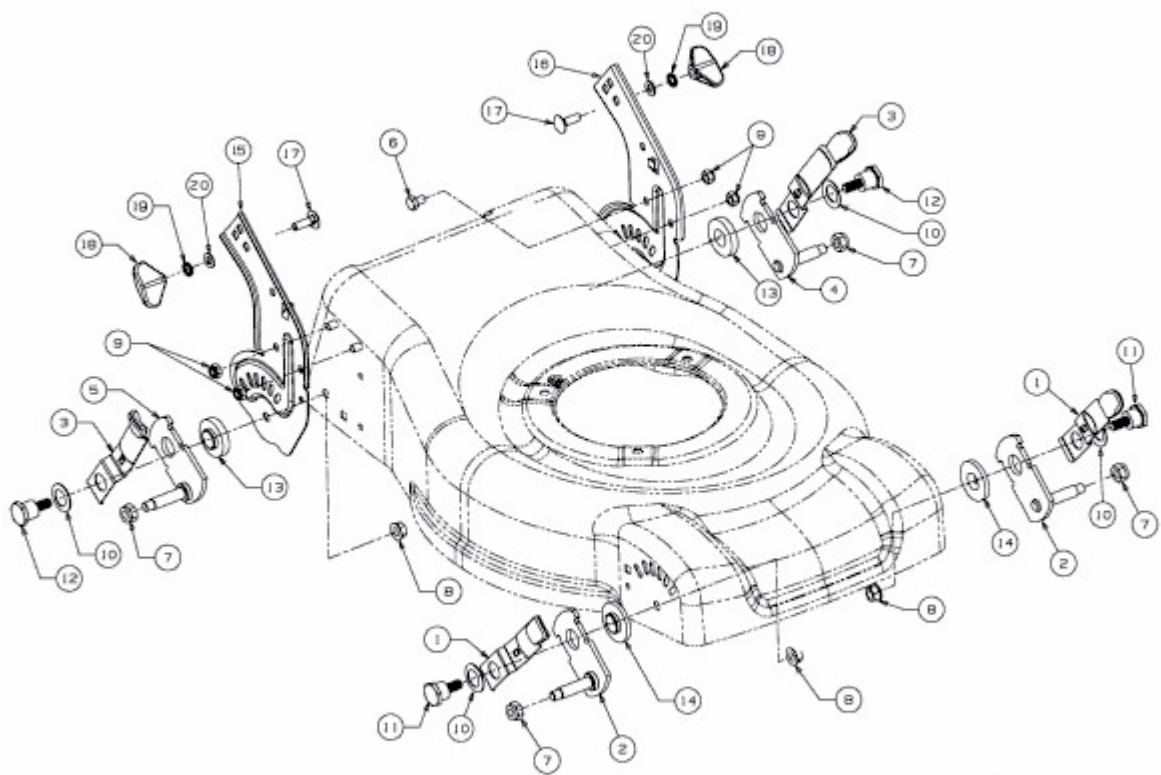

E3-04793A-01