

B 48 HM > 11C-128R694 (2013) > GRASFANGSACK, HECKKLAPPE

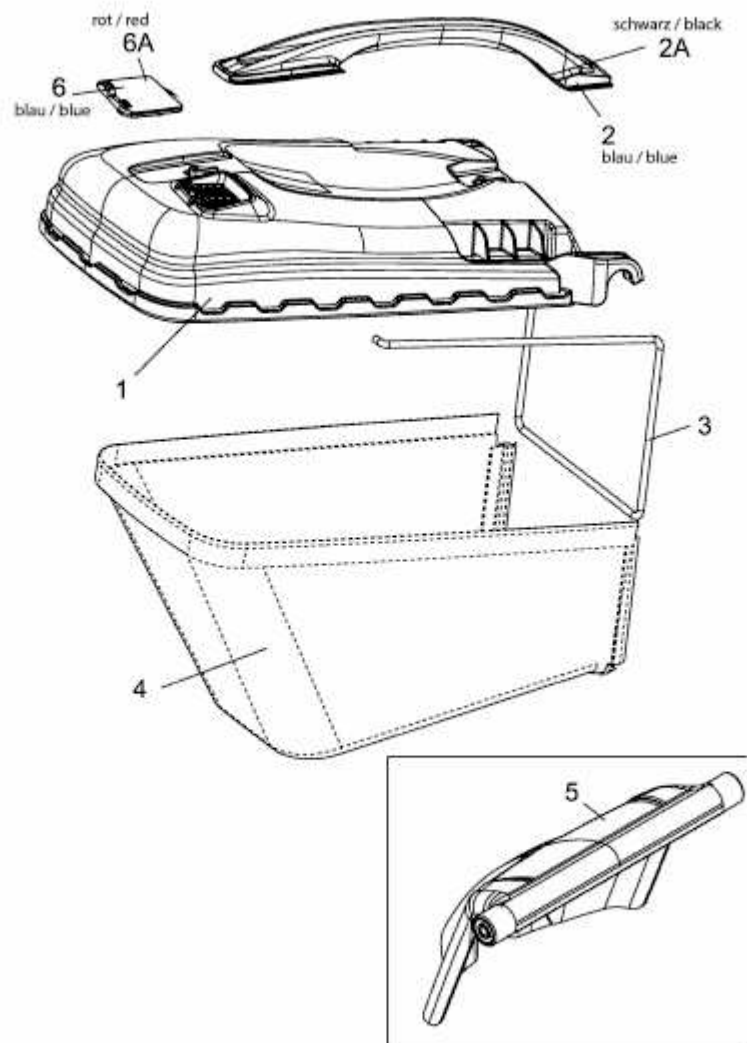

E3-05364A-01