

ab 01/05/2018
effective from 05/01/2018
à partir du 01/05/2018

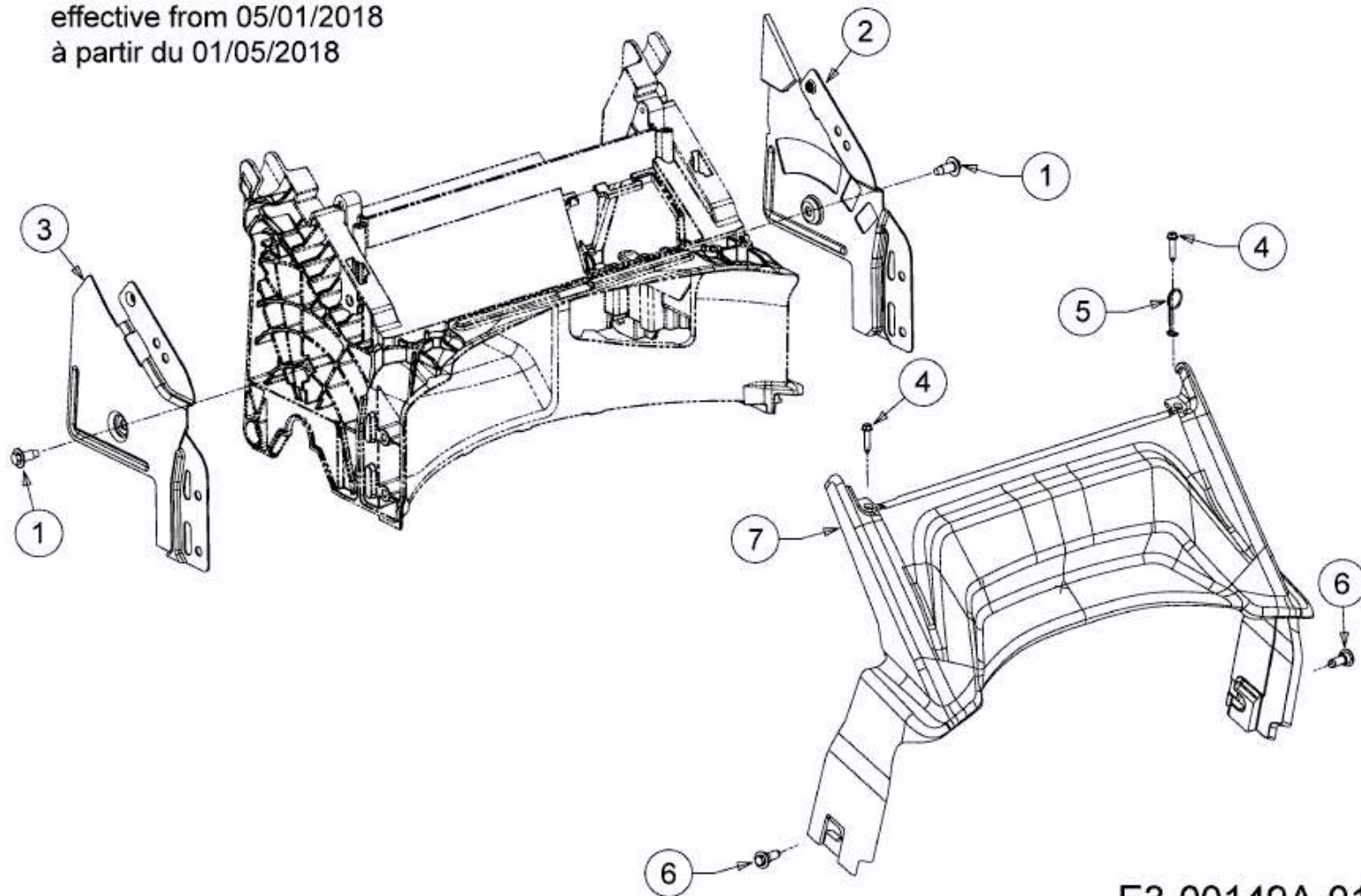

E3-00149A-01