

ab 01/05/2018

effective from 05/01/2018

à partir du 01/05/2018

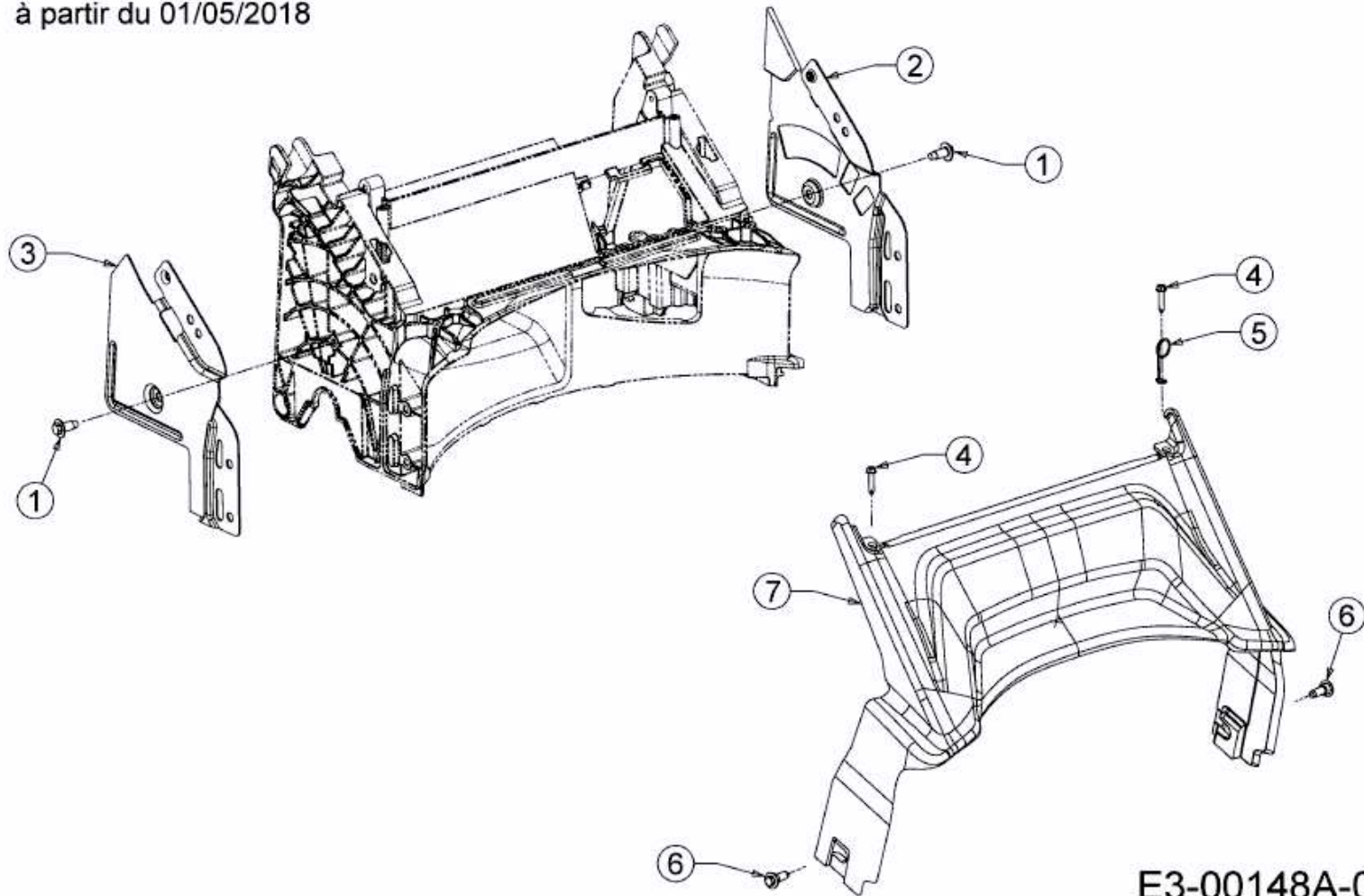

E3-00148A-01