

40 PO-HQ > 11B-I1JD616 (2011) > MÄHWERKSGEHÄUSE

MOTOR / ENGINE

nicht abgebildet / not shown

10	MTD - MOTOR / ENGINE für MOD. P 40 PO
11	MTD - MOTOR / ENGINE für MOD. Select 4000 , 40 PO , 40PO-HQ , BH 40
12	B&S - MOTOR / ENGINE MOD. 40 PB , P 40 B , GBR 40 (2010)
13	B&S - MOTOR / ENGINE für MOD. GBR 40 ECO (2011, 2012)
14	B&S - MOTOR / ENGINE für MOD. D 4040 P3
15	B&S - MOTOR / ENGINE für MOD. GBR 40 ECO (2013 , 11A-115F666)

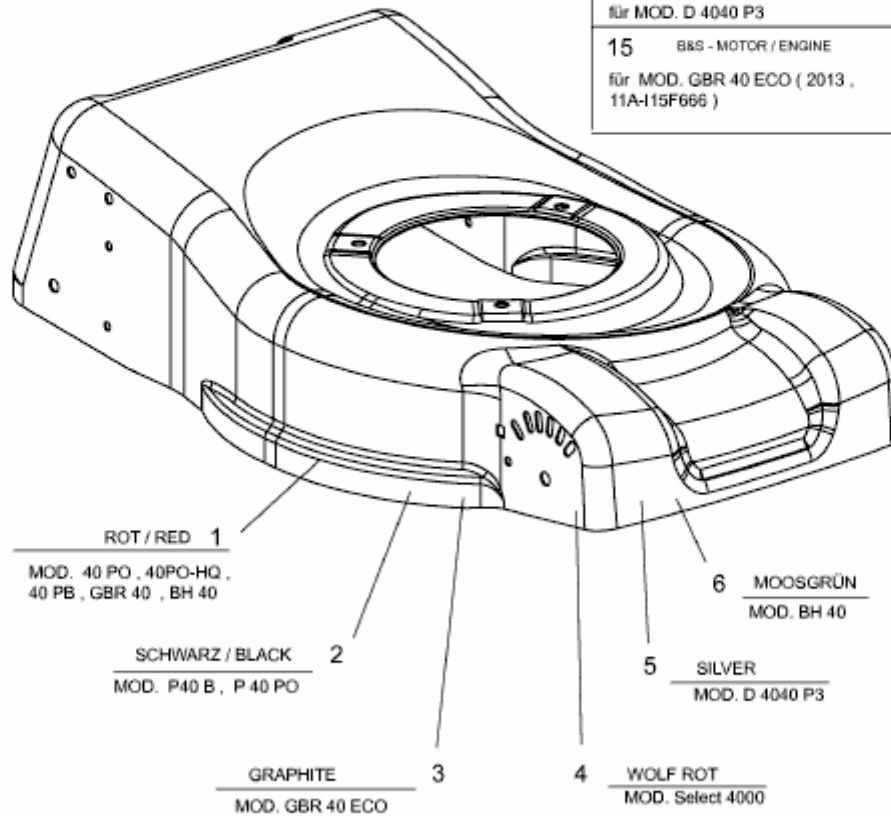

E3-04781B-01