

GBR 40 ECO > 11B-I14E666 (2012) > SCHNITTHÖHENVERSTELLUNG

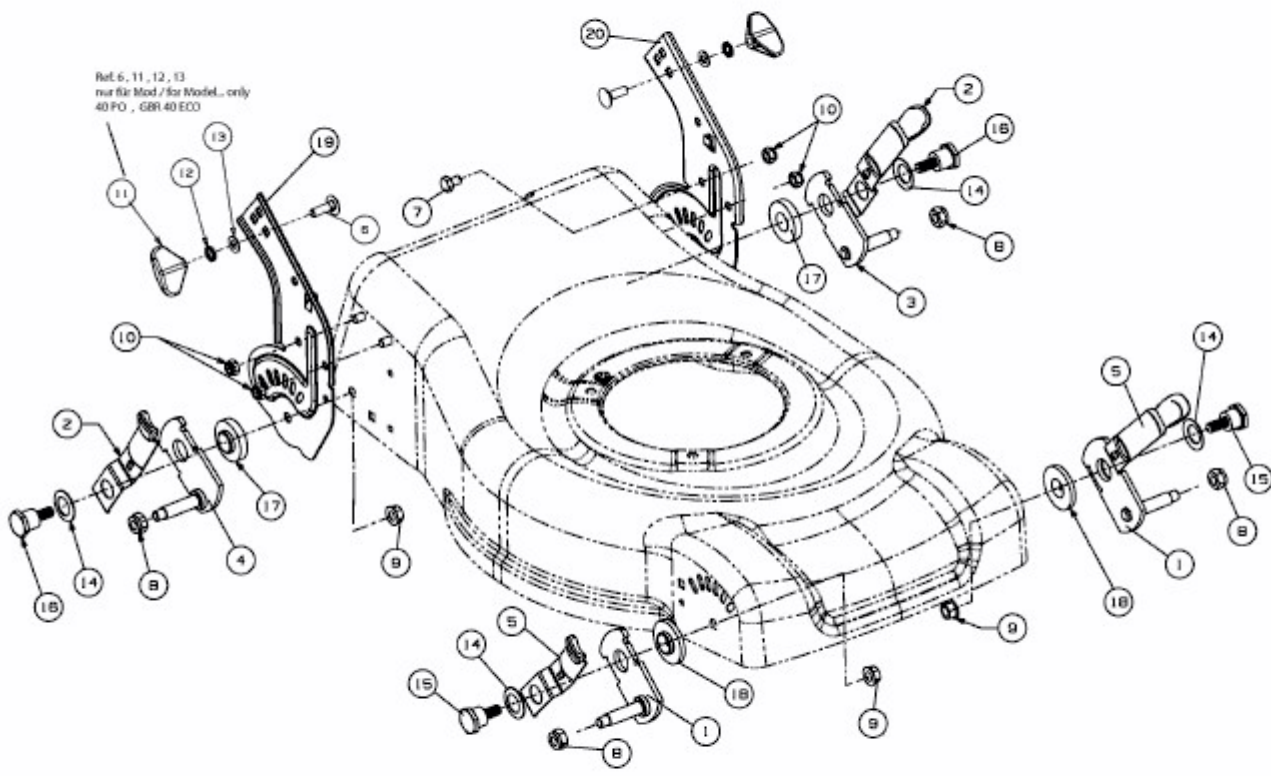

E3-05681A-01