

GBR 40 > 11B-I10G666 (2010) > SCHNITTHÖHENVERSTELLUNG

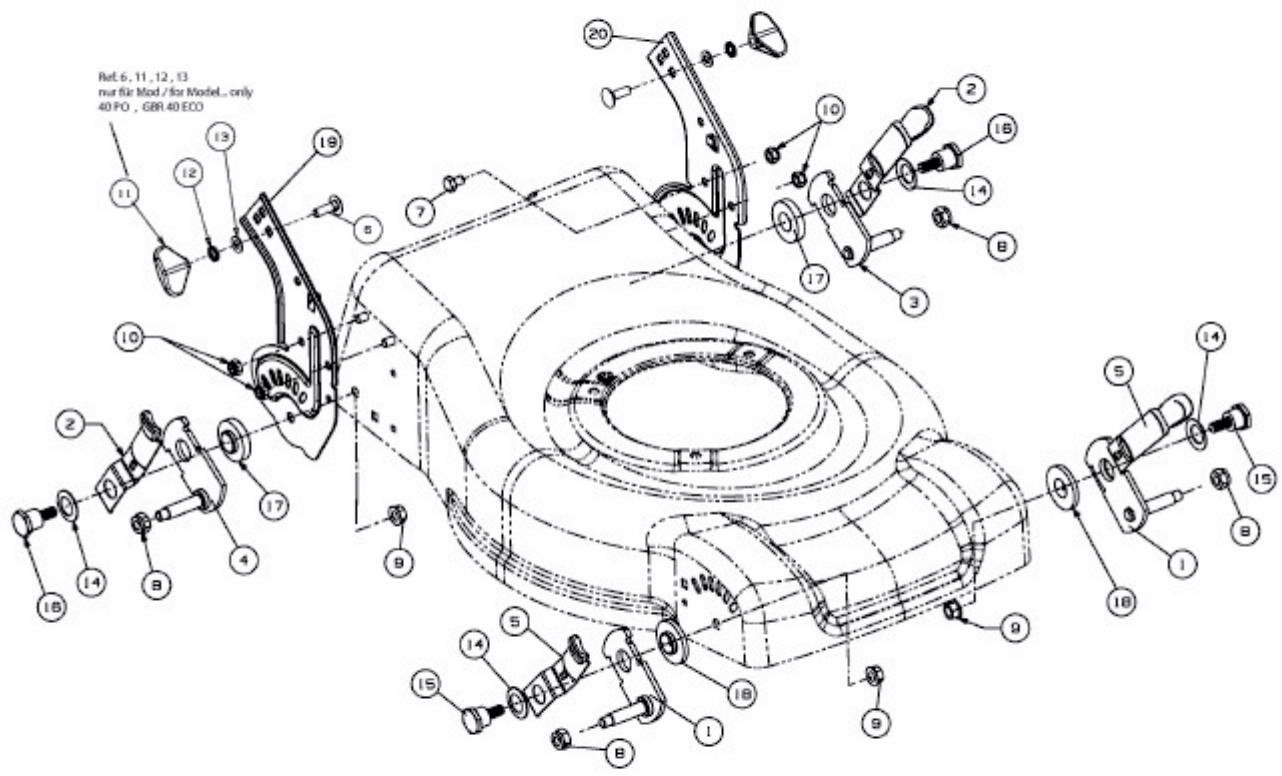

E3-05681A-01