

B 48 HM > 11B-128R694 (2011) > GRASFANGSACK, HECKKLAPPE

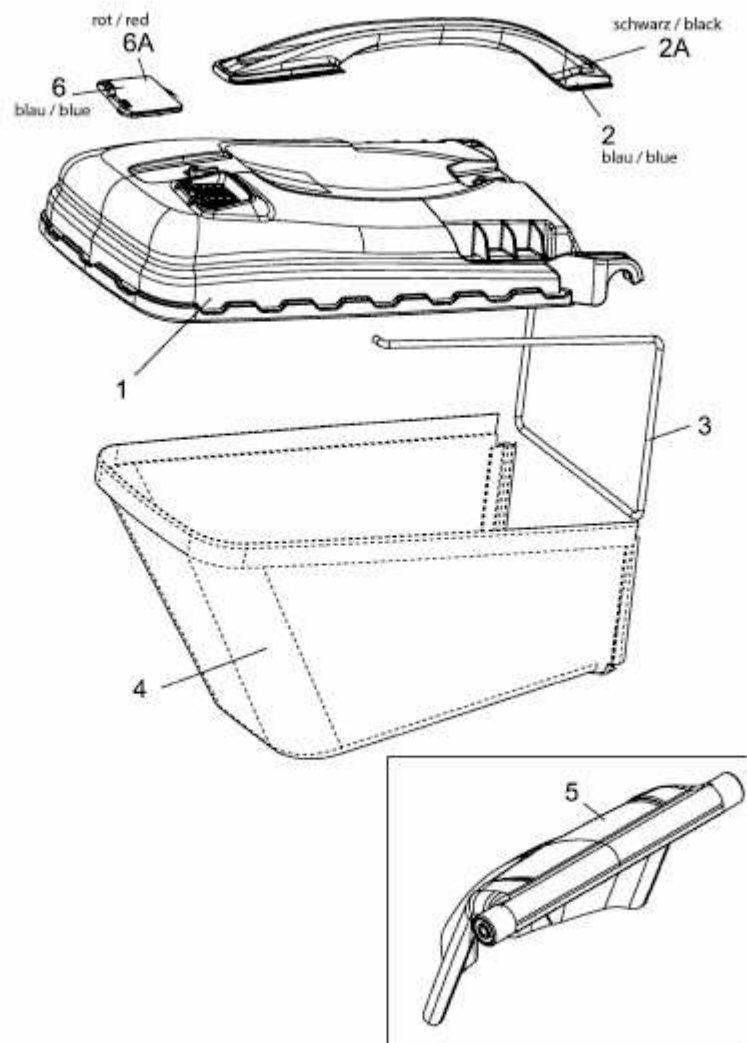

E3-05364A-01